

0.50 mm FPCh200 RIGHT ANGLE SURFACE MOUNT TYPE- Rt

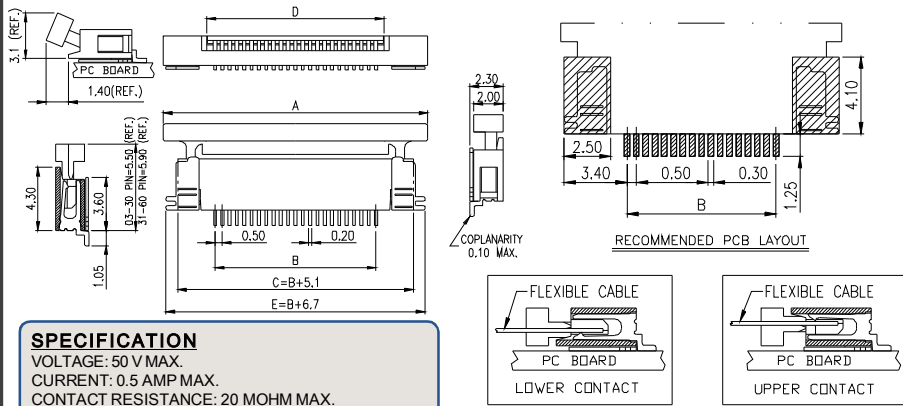

SPECIFICATION
 VOLTAGE: 50 V MAX.
 CURRENT: 0.5 AMP MAX.
 CONTACT RESISTANCE: 20 MOHM MAX.
 INSULATION RESISTANCE: 50 MOHM MIN.
 DIELECTRIC WITHSTANDING VOLTAGE: 250 V AC.
 OPERATING TEMPERATURE: - 40°C ~ + 85°C

MATERIALS
 HOUSING: NYLON 6T, UL 94V-0 RATED
 ACTUATOR: HIGH-TEMP THERMOPLASTIC; UL94V-0
 CONTACT: PHOSPHOR BRONZE, PLATING: TIN.
 HOLDDOWN: BRASS, PLATING: TIN.

PART NO.	NO. OF CONTACTS	DIMENSIONS				
		A	B	C	D	E
FPCh200-R103T-X-X	3	8.10	1.00	6.10	2.11	7.70
FPCh200-R104T-X-X	4	8.60	1.50	6.60	2.61	8.20
FPCh200-R105T-X-X	5	9.10	2.00	7.10	3.11	8.70
FPCh200-R106T-X-X	6	9.60	2.50	7.60	3.61	9.20
FPCh200-R107T-X-X	7	10.10	3.00	8.10	4.11	9.70
FPCh200-R108T-X-X	8	10.60	3.50	8.60	4.61	10.20
FPCh200-R109T-X-X	9	11.10	4.00	9.10	5.11	10.70
FPCh200-R110T-X-X	10	11.60	4.50	9.60	5.61	11.20
FPCh200-R111T-X-X	11	12.10	5.00	10.10	6.11	11.70
FPCh200-R112T-X-X	12	12.60	5.50	10.60	6.61	12.20
FPCh200-R113T-X-X	13	13.10	6.00	11.10	7.11	12.70
FPCh200-R114T-X-X	14	13.60	6.50	11.60	7.61	13.20
FPCh200-R115T-X-X	15	14.10	7.00	12.10	8.11	13.70
FPCh200-R116T-X-X	16	14.60	7.50	12.60	8.61	14.20
FPCh200-R117T-X-X	17	15.10	8.00	13.10	9.11	14.70
FPCh200-R118T-X-X	18	15.60	8.50	13.60	9.61	15.20
FPCh200-R119T-X-X	19	16.10	9.00	14.10	10.11	15.70
FPCh200-R120T-X-X	20	16.60	9.50	14.60	10.61	16.20
FPCh200-R121T-X-X	21	17.10	10.00	15.10	11.11	16.70
FPCh200-R122T-X-X	22	17.60	10.50	15.60	11.61	17.20
FPCh200-R123T-X-X	23	18.10	11.00	16.10	12.11	17.70
FPCh200-R124T-X-X	24	18.60	11.50	16.60	12.61	18.20
FPCh200-R125T-X-X	25	19.10	12.00	17.10	13.11	18.70
FPCh200-R126T-X-X	26	19.60	12.50	17.60	13.61	19.20
FPCh200-R127T-X-X	27	20.10	13.00	18.10	14.11	19.70
FPCh200-R128T-X-X	28	20.60	13.50	18.60	14.61	20.20
FPCh200-R129T-X-X	29	21.10	14.00	19.10	15.11	20.70
FPCh200-R130T-X-X	30	21.60	14.50	19.60	15.61	21.20
FPCh200-R131T-X-X	31	22.10	15.00	20.10	16.11	21.70
FPCh200-R132T-X-X	32	22.60	15.50	20.60	16.61	22.20
FPCh200-R133T-X-X	33	23.10	16.00	21.10	17.11	22.70
FPCh200-R134T-X-X	34	23.60	16.50	21.60	17.61	23.20
FPCh200-R135T-X-X	35	24.10	17.00	22.10	18.11	23.70
FPCh200-R136T-X-X	36	24.60	17.50	22.60	18.61	24.20
FPCh200-R137T-X-X	37	25.10	18.00	23.10	19.11	24.70
FPCh200-R138T-X-X	38	25.60	18.50	23.60	19.61	25.20
FPCh200-R139T-X-X	39	26.10	19.00	24.10	20.11	25.70
FPCh200-R140T-X-X	40	26.60	19.50	24.60	20.61	26.20
FPCh200-R141T-X-X	41	27.10	20.00	25.10	21.11	26.70
FPCh200-R142T-X-X	42	27.60	20.50	25.60	21.61	27.20
FPCh200-R143T-X-X	43	28.10	21.00	26.10	22.11	27.70
FPCh200-R144T-X-X	44	28.60	21.50	26.60	22.61	28.20
FPCh200-R145T-X-X	45	29.10	22.00	27.10	23.11	28.70
FPCh200-R146T-X-X	46	29.60	22.50	27.60	23.61	29.20
FPCh200-R147T-X-X	47	30.10	23.00	28.10	24.11	29.70
FPCh200-R148T-X-X	48	30.60	23.50	28.60	24.61	30.20
FPCh200-R149T-X-X	49	31.10	24.00	29.10	25.11	30.70
FPCh200-R150T-X-X	50	31.60	24.50	29.60	25.61	31.20
FPCh200-R151T-X-X	51	32.10	25.00	30.10	26.11	31.70
FPCh200-R152T-X-X	52	32.60	25.50	30.60	26.61	32.20
FPCh200-R153T-X-X	53	33.10	26.00	31.10	27.11	32.70
FPCh200-R154T-X-X	54	33.60	26.50	31.60	27.61	33.20
FPCh200-R155T-X-X	55	34.10	27.00	32.10	28.11	33.70
FPCh200-R156T-X-X	56	34.60	27.50	32.60	28.61	34.20
FPCh200-R157T-X-X	57	35.10	28.00	33.10	29.11	34.70
FPCh200-R158T-X-X	58	35.60	28.50	33.60	29.61	35.20
FPCh200-R159T-X-X	59	36.10	29.00	34.10	30.11	35.70
FPCh200-R160T-X-X	60	36.60	29.50	34.60	30.61	36.20

FPC h 200 - Rt XX T - X - X

PITCH
h: 0.50 mm

SERIES NO.
200

PCB TYPE
Rt: RIGHT ANGLE SURFACE MOUNT TYPE

NO. OF PIN
03-60

PACKAGE
T: TUBE
T/R: TAPE & REEL

CONTACT TYPE
U: UPPER CONTACT (TOP CONTACT)
BLANK: LOWER CONTACT (BOTTOM CONTACT)

PLATING
TIN PLATED OVER ALL

FPC CONNECTOR

0.50 mm FPCh204 RIGHT ANGLE SURFACE MOUNT TYPE- Rt

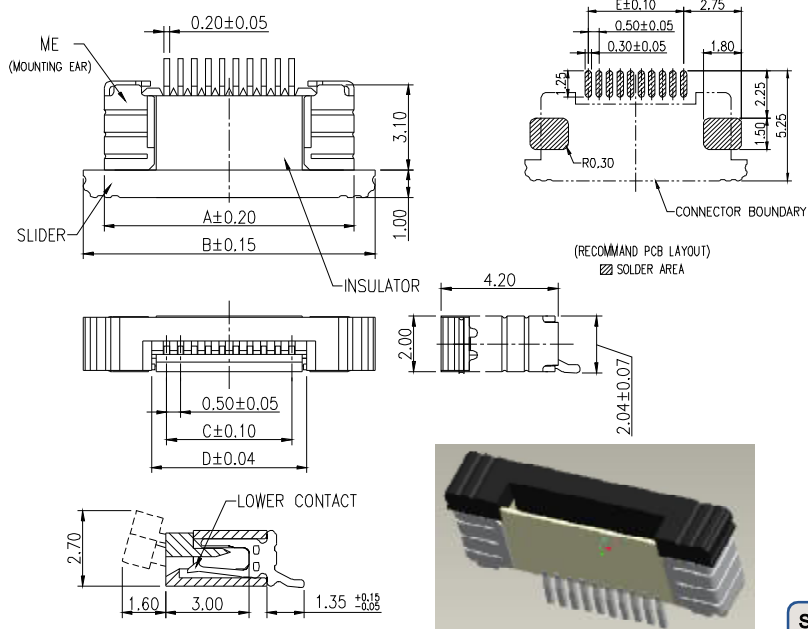

MODEL NO.	NO. OF CONTACTS	DIMENSIONS				
		A	B	C	D	E
FPCh204-R104T-X	4	6.00	7.50	1.50	2.62	1.50
FPCh204-R105T-X	5	6.50	8.00	2.00	3.12	2.00
FPCh204-R106T-X	6	7.00	8.50	2.50	3.62	2.50
FPCh204-R107T-X	7	7.50	9.00	3.00	4.12	3.00
FPCh204-R108T-X	8	8.00	9.50	3.50	4.62	3.50
FPCh204-R109T-X	9	8.50	10.00	4.00	5.12	4.00
FPCh204-R110T-X	10	9.00	10.50	4.50	5.62	4.50
FPCh204-R111T-X	11	9.50	11.00	5.00	6.12	5.00
FPCh204-R112T-X	12	10.00	11.50	5.50	6.62	5.50
FPCh204-R113T-X	13	10.50	12.00	6.00	7.12	6.00
FPCh204-R114T-X	14	11.00	12.50	6.50	7.62	6.50
FPCh204-R115T-X	15	11.50	13.00	7.00	8.12	7.00
FPCh204-R116T-X	16	12.00	13.50	7.50	8.62	7.50
FPCh204-R117T-X	17	12.50	14.00	8.00	9.12	8.00
FPCh204-R118T-X	18	13.00	14.50	8.50	9.62	8.50
FPCh204-R119T-X	19	13.50	15.00	9.00	10.12	9.00
FPCh204-R120T-X	20	14.00	15.50	9.50	10.62	9.50
FPCh204-R121T-X	21	14.50	16.00	10.00	11.12	10.00
FPCh204-R122T-X	22	15.00	16.50	10.50	11.62	10.50
FPCh204-R123T-X	23	15.50	17.00	11.00	12.12	11.00
FPCh204-R124T-X	24	16.00	17.50	11.50	12.62	11.50
FPCh204-R125T-X	25	16.50	18.00	12.00	13.12	12.00
FPCh204-R126T-X	26	17.00	18.50	12.50	13.62	12.50
FPCh204-R127T-X	27	17.50	19.00	13.00	14.12	13.00
FPCh204-R128T-X	28	18.00	19.50	13.50	14.62	13.50
FPCh204-R129T-X	29	18.50	20.00	14.00	15.12	14.00
FPCh204-R130T-X	30	19.00	20.50	14.50	15.62	14.50
FPCh204-R131T-X	31	19.50	21.00	15.00	16.12	15.00
FPCh204-R132T-X	32	20.00	21.50	15.50	16.62	15.50
FPCh204-R133T-X	33	20.50	22.00	16.00	17.12	16.00
FPCh204-R134T-X	34	21.00	22.50	16.50	17.62	16.50
FPCh204-R135T-X	35	21.50	23.00	17.00	18.12	17.00
FPCh204-R136T-X	36	22.00	23.50	17.50	18.62	17.50
FPCh204-R137T-X	37	22.50	24.00	18.00	19.12	18.00
FPCh204-R138T-X	38	23.00	24.50	18.50	19.62	18.50
FPCh204-R139T-X	39	23.50	25.00	19.00	20.12	19.00
FPCh204-R140T-X	40	24.00	25.50	19.50	20.62	19.50

FPC h 204 - Rt XX T - X

PITCH
h: 0.50 mm

SERIES NO.
204: BOTTOM CONTACT

NO. OF PIN
04-40

PACKAGE
T: TUBE
T/R: TAPE & REEL

PCB TYPE
Rt: RIGHT ANGLE SURFACE MOUNT TYPE

PLATING
TIN PLATED OVER ALL

FPC CONNECTOR

SPECIFICATION
 OPERATING VOLTAGE: 50 VAC
 CURRENT RATING: 0.5 AMP
 CONTACT RESISTANCE: 20 MOHM MAX.
 INSULATION RESISTANCE: 50 MOHM MIN.
 DIELECTRIC WITHSTANDING VOLTAGE: 250 VAC RMS.
 ACCOMMODATED FFC/FPC THICKNESS: 0.30±0.03 mm
 OPERATING TEMPERATURE: - 20°C ~ + 85°C

MATERIALS
 INSULATOR: PA9T, UL94V-0 RATED(COLOR: NATURAL)
 SLIDER: PPS; UL94V-0 RATED(COLOR: BROWN/BLACK)
 TERMINAL : PHOSPHOR BRONZE
 ME: PHOSPHOR BRONZE

NOTE : SOME SIZES, STYLES AND OPTION ARE NON-STANDARD, NON-CANCELLABLE, NON-RETURNABLE

0.50 mm FPCh207 RIGHT ANGLE SURFACE MOUNT TYPE-Rt

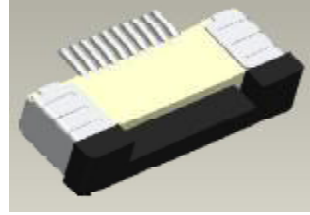
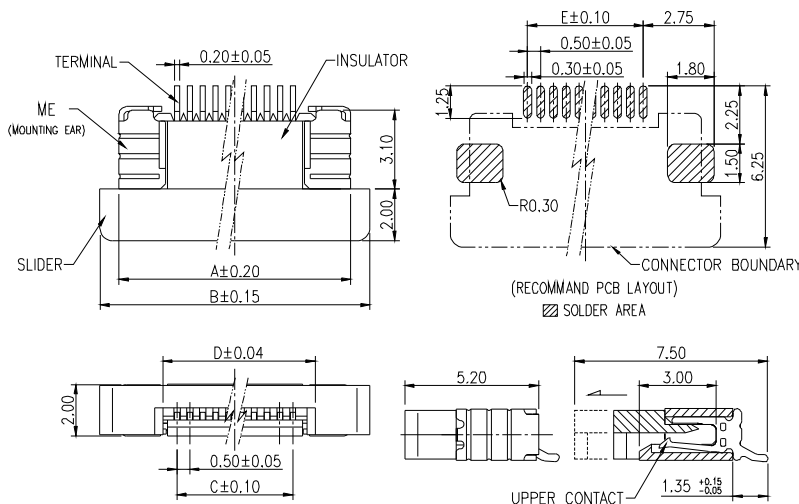

SPECIFICATION

OPERATING VOLTAGE: 50 VAC
 CURRENT RATING: 0.5 AMP
 CONTACT RESISTANCE: 20 MOHM MAX.
 INSULATION RESISTANCE: 50 MOHM MIN.
 DIELECTRIC WITHSTANDING VOLTAGE:
 250 VAC RMS.
 ACCOMMODATED FFC/FPC THICKNESS:
 0.30±0.03 mm
 OPERATING TEMPERATURE: -20°C ~ +85°C

MATERIALS

INSULATOR: PA9T, UL94V-0 RATED
 (COLOR: NATURAL)
 SLIDER: PPS; UL94V-0 RATED
 (COLOR: BROWN/ BLACK)
 TERMINAL : PHOSPHOR BRONZE
 ME: PHOSPHOR BRONZE

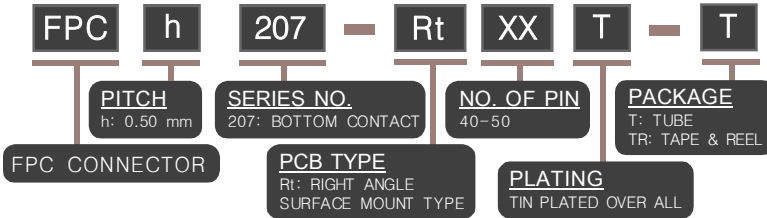

MODEL NO.	No. of Pins	DIMENSIONS				
		A	B	C	D	E
FPCh207L-R140T-T	40	24.00	25.50	19.50	20.62	19.50
FPCh207L-R141T-T	41	24.50	26.00	20.00	21.12	20.00
FPCh207L-R142T-T	42	25.00	26.50	20.50	21.62	20.50
FPCh207L-R143T-T	43	25.50	27.00	21.00	22.12	21.00
FPCh207L-R144T-T	44	26.00	27.50	21.50	22.62	21.50
FPCh207L-R145T-T	45	26.50	28.00	22.00	23.12	22.00
FPCh207L-R146T-T	46	27.00	28.50	22.50	23.62	22.50
FPCh207L-R147T-T	47	27.50	29.00	23.00	24.12	23.00
FPCh207L-R148T-T	48	28.00	29.50	23.50	24.62	23.50
FPCh207L-R149T-T	49	28.50	30.00	24.00	25.12	24.00
FPCh207L-R150T-T	50	29.00	30.50	24.50	25.62	24.50

0.50 mm FPCh213 RIGHT ANGLE SURFACE MOUNT TYPE-Rt

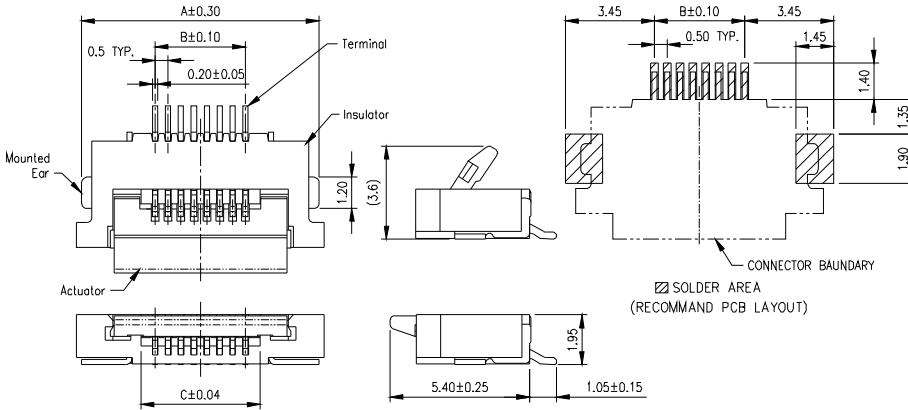

MODEL NO.	No. OF CONTACTS	DIMENSIONS		
		A	B	C
FPCh213-R104T-X	4P	7.20	1.50	2.62
FPCh213-R105T-X	5P	7.70	2.00	3.12
FPCh213-R106T-X	6P	8.20	2.50	3.62
FPCh213-R107T-X	7P	8.70	3.00	4.12
FPCh213-R108T-X	8P	9.20	3.50	4.62
FPCh213-R109T-X	9P	9.70	4.00	5.12
FPCh213-R110T-X	10P	10.20	4.50	5.62
FPCh213-R111T-X	11P	10.70	5.00	6.12
FPCh213-R112T-X	12P	11.20	5.50	6.62
FPCh213-R113T-X	13P	11.70	6.00	7.12
FPCh213-R114T-X	14P	12.20	6.50	7.62
FPCh213-R115T-X	15P	12.70	7.00	8.12
FPCh213-R116T-X	16P	13.20	7.50	8.62
FPCh213-R117T-X	17P	13.70	8.00	9.12
FPCh213-R118T-X	18P	14.20	8.50	9.62
FPCh213-R119T-X	19P	14.70	9.00	10.12
FPCh213-R120T-X	20P	15.20	9.50	10.62
FPCh213-R121T-X	21P	15.70	10.00	11.12
FPCh213-R122T-X	22P	16.20	10.50	11.62
FPCh213-R123T-X	23P	16.70	11.00	12.12
FPCh213-R124T-X	24P	17.20	11.50	12.62
FPCh213-R125T-X	25P	17.70	12.00	13.12
FPCh213-R126T-X	26P	18.20	12.50	13.62
FPCh213-R127T-X	27P	18.70	13.00	14.12
FPCh213-R128T-X	28P	19.20	13.50	14.62
FPCh213-R129T-X	29P	19.70	14.00	15.12
FPCh213-R130T-X	30P	20.20	14.50	15.62
FPCh213-R131T-X	31P	20.70	15.00	16.12
FPCh213-R132T-X	32P	21.20	15.50	16.62
FPCh213-R133T-X	33P	21.70	16.00	17.12
FPCh213-R134T-X	34P	22.20	16.50	17.62
FPCh213-R135T-X	35P	22.70	17.00	18.12
FPCh213-R136T-X	36P	23.20	17.50	18.62
FPCh213-R137T-X	37P	23.70	18.00	19.12
FPCh213-R138T-X	38P	24.20	18.50	19.62
FPCh213-R139T-X	39P	24.70	19.00	20.12
FPCh213-R140T-X	40P	25.20	19.50	20.62
FPCh213-R141T-X	41P	25.70	20.00	21.12
FPCh213-R142T-X	42P	26.20	20.50	21.62
FPCh213-R143T-X	43P	26.70	21.00	22.12
FPCh213-R144T-X	44P	27.20	21.50	22.62
FPCh213-R145T-X	45P	27.70	22.00	23.12
FPCh213-R146T-X	46P	28.20	22.50	23.62
FPCh213-R147T-X	47P	28.70	23.00	24.12
FPCh213-R148T-X	48P	29.20	23.50	24.62
FPCh213-R149T-X	49P	29.70	24.00	25.12
FPCh213-R150T-X	50P	30.20	24.50	25.62
FPCh213-R151T-X	51P	30.70	25.00	26.12
FPCh213-R152T-X	52P	31.20	25.50	26.62
FPCh213-R153T-X	53P	31.70	26.00	27.12
FPCh213-R154T-X	54P	32.20	26.50	27.62
FPCh213-R155T-X	55P	32.70	27.00	28.12
FPCh213-R156T-X	56P	33.20	27.50	28.62
FPCh213-R157T-X	57P	33.70	28.00	29.12
FPCh213-R158T-X	58P	34.20	28.50	29.62
FPCh213-R159T-X	59P	34.70	29.00	30.12
FPCh213-R160T-X	60P	35.20	29.50	30.62

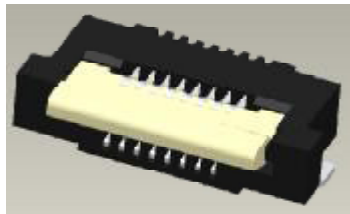

SPECIFICATION
 OPERATING VOLTAGE: 50 VAC
 CURRENT RATING: 0.5 AMP
 CONTACT RESISTANCE: 20 MOHM MAX.
 INSULATION RESISTANCE: 50 MOHM MIN.
 DIELECTRIC WITHSTANDING VOLTAGE: 250 VAC RMS.
 ACCOMMODATED FFC/FPC THICKNESS: 0.30±0.03 mm
 OPERATING TEMPERATURE: -20°C ~ +85°C

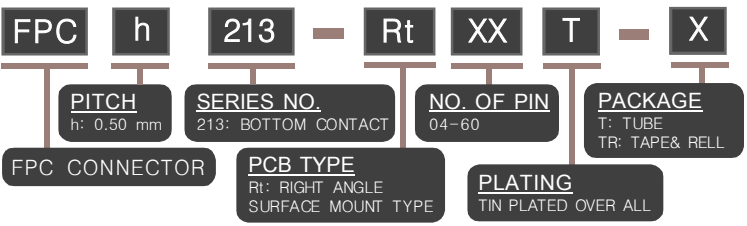

MATERIALS
 INSULATOR: PA9T, UL94V-0 RATED
 ACTUATOR: PPS; UL94V-0 RATED
 TERMINAL : PHOSPHOR BRONZE

NOTE : SOME SIZES, STYLES AND OPTION ARE NON-STANDARD, NON-CANCELLABLE, NON-RETURNABLE

0.50 mm FPCh211 RIGHT ANGLE SURFACE MOUNT TYPE- Rt

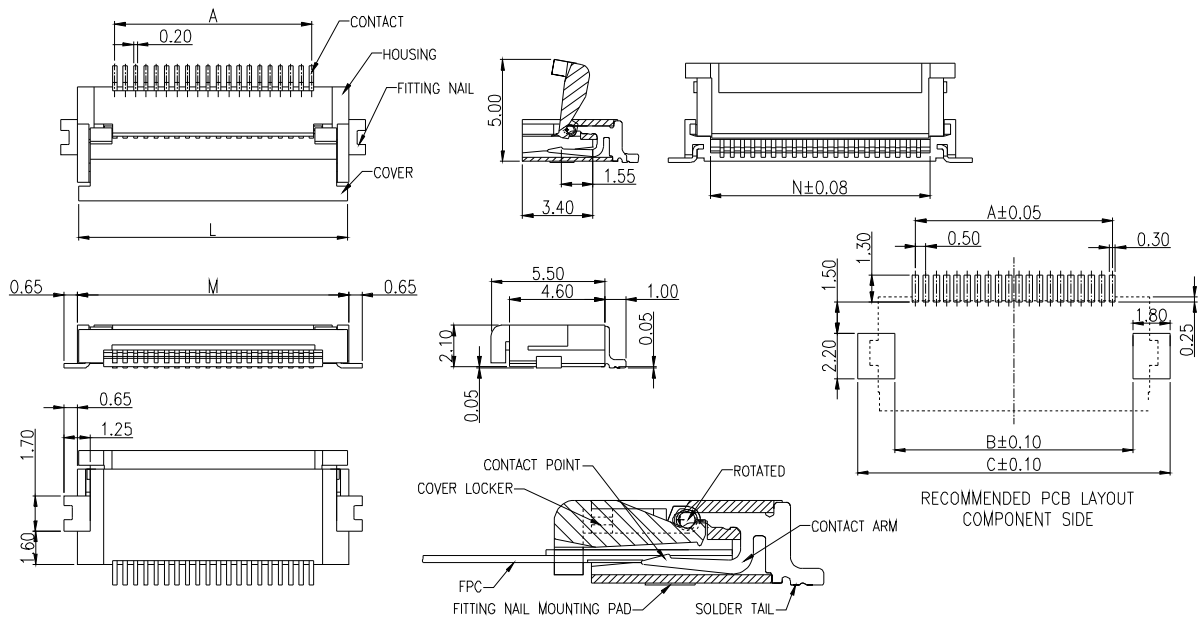

NO. OF CONTACTS	DIMENSIONS						NO. OF CONTACTS	DIMENSIONS					
	A	B	C	L	M	N		A	B	C	L	M	N
4	1.50	3.50	7.10	5.00	5.10	2.60	31	15.00	17.00	20.60	18.50	18.60	16.10
5	2.00	4.00	7.60	5.50	5.60	3.10	32	15.50	17.50	21.10	19.00	19.10	16.60
6	2.50	4.50	8.10	6.00	6.10	3.60	33	16.00	18.00	21.60	19.50	19.60	17.10
7	3.00	5.00	8.60	6.50	6.60	4.10	34	16.50	18.50	22.10	20.00	20.10	17.60
8	3.50	5.50	9.10	7.00	7.10	4.60	35	17.00	19.00	22.60	20.50	20.60	18.10
9	4.00	6.00	9.60	7.50	7.60	5.10	36	17.50	19.50	23.10	21.00	21.10	18.60
10	4.50	6.50	10.10	8.00	8.10	5.60	37	18.00	20.00	23.60	21.50	21.60	19.10
11	5.00	7.00	10.60	8.50	8.60	6.10	38	18.50	20.50	24.10	22.00	22.10	19.60
12	5.50	7.50	11.10	9.00	9.10	6.60	39	19.00	21.00	24.60	22.50	22.60	20.10
13	6.00	8.00	11.60	9.50	9.60	7.10	40	19.50	21.50	25.10	23.00	23.10	20.60
14	6.50	8.50	12.10	10.00	10.10	7.60	41	20.00	22.00	25.60	23.50	23.60	21.10
15	7.00	9.00	12.60	10.50	10.60	8.10	42	20.50	22.50	26.10	24.00	24.10	21.60
16	7.50	9.50	13.10	11.00	11.10	8.60	43	21.00	23.00	26.60	24.50	24.60	22.10
17	8.00	10.00	13.60	11.50	11.60	9.10	44	21.50	23.50	27.10	25.00	25.10	22.60
18	8.50	10.50	14.10	12.00	12.10	9.60	45	22.00	24.00	27.60	25.50	25.60	23.10
19	9.00	11.00	14.60	12.50	12.60	10.10	46	22.50	24.50	28.10	26.00	26.10	23.60
20	9.50	11.50	15.10	13.00	13.10	10.60	47	23.00	25.00	28.60	26.50	26.60	24.10
21	10.00	12.00	15.60	13.50	13.60	11.10	48	23.50	25.50	29.10	27.00	27.10	24.60
22	10.50	12.50	16.10	14.00	14.10	11.60	49	24.00	26.00	29.60	27.50	27.60	25.10
23	11.00	13.00	16.60	14.50	14.60	12.10	50	24.50	26.50	30.10	28.00	28.10	25.60
24	11.50	13.50	17.10	15.00	15.10	12.60	51	25.00	27.00	30.60	28.50	28.60	26.10
25	12.00	14.00	17.60	15.50	15.60	13.10	52	25.50	27.50	31.10	29.00	29.10	26.60
26	12.50	14.50	18.10	16.00	16.10	13.60	53	26.00	28.00	31.60	29.50	29.60	27.10
27	13.00	15.00	18.60	16.50	16.60	14.10	54	26.50	28.50	32.10	30.00	30.10	27.60
28	13.50	15.50	19.10	17.00	17.10	14.60	55	27.00	29.00	32.60	30.50	30.60	28.10
29	14.00	16.00	19.60	17.50	17.60	15.10	56	27.50	29.50	33.10	31.00	31.10	28.60
30	14.50	16.50	20.10	18.00	18.10	15.60	57	28.00	30.00	33.60	31.50	31.60	29.10

MATERIALS

HOUSING: THERMAPLASTIC, HEATPROOF PLASTIC(UL94 V-0)
 COVER: THERMAPLASTIC (UL94 V-0)
 CONTACT: PHOSPHOR BRONZE

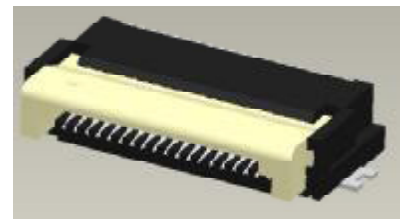
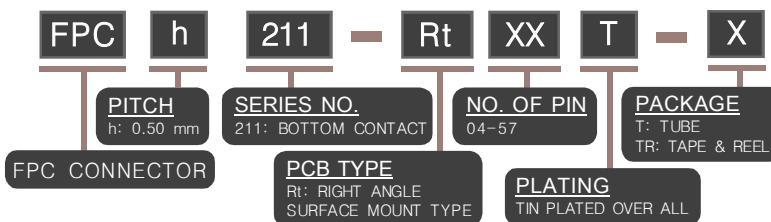

NOTE : SOME SIZES, STYLES AND OPTION ARE NON-STANDARD, NON-CANCELLABLE, NON-RETURNABLE

0.50 mm FPC_h216RIGHT ANGLE SURFACE MOUNT TYPE-R_t

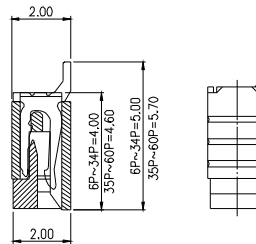
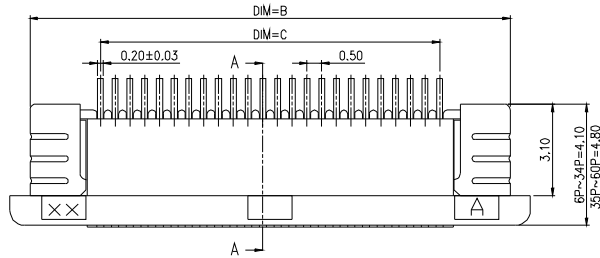
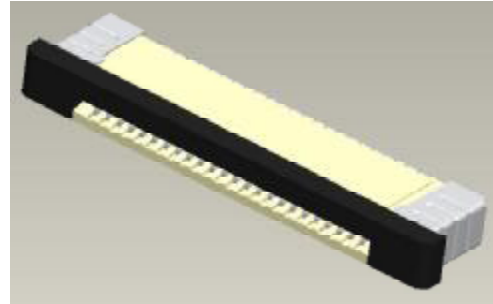
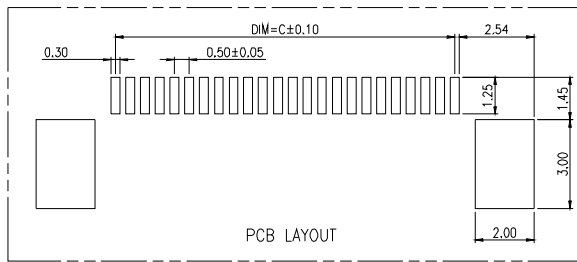

NO. OF PINS	DIMENSIONS				NO. OF PINS	DIMENSIONS			
	A	B	C	D		A	B	C	D
6	8.60	7.30	2.50	3.80	35	23.10	21.80	17.00	18.30
7	9.10	7.80	3.00	4.30	36	23.60	22.30	17.50	18.80
8	9.60	8.30	3.50	4.80	37	24.10	22.80	18.00	19.30
9	10.10	8.80	4.00	5.30	38	24.60	23.30	18.50	19.80
10	10.60	9.30	4.50	5.80	39	25.10	23.80	19.00	20.30
11	11.10	9.80	5.00	6.30	40	25.60	24.30	19.50	20.80
12	11.60	10.30	5.50	6.80	41	26.10	24.80	20.00	21.30
13	12.10	10.80	6.00	7.30	42	26.60	25.30	20.50	21.80
14	12.60	11.30	6.50	7.80	43	27.10	25.80	21.00	22.30
15	13.10	11.80	7.00	8.30	44	27.60	26.30	21.50	22.80
16	13.60	12.30	7.50	8.80	45	28.10	26.80	22.00	23.30
17	14.10	12.80	8.00	9.30	46	28.60	27.30	22.50	23.80
18	14.60	13.30	8.50	9.80	47	29.10	27.80	23.00	24.30
19	15.10	13.80	9.00	10.30	48	29.60	28.30	23.50	24.80
20	15.60	14.30	9.50	10.80	49	30.10	28.80	24.00	25.30
21	16.10	14.80	10.00	11.30	50	30.60	29.30	24.50	25.80
22	16.60	15.30	10.50	11.80	51	31.10	29.80	25.00	26.30
23	17.10	15.80	11.00	12.30	52	31.60	30.30	25.50	26.80
24	17.60	16.30	11.50	12.80	53	32.10	30.80	26.00	27.30
25	18.10	16.80	12.00	13.30	54	32.60	31.30	26.50	27.80
26	18.60	17.30	12.50	13.80	55	33.10	31.80	27.00	28.30
27	19.10	17.80	13.00	14.30	56	33.60	32.30	27.50	28.80
28	19.60	18.30	13.50	14.80	57	34.10	32.80	28.00	29.30
29	20.10	18.80	14.00	15.30	58	34.60	33.30	28.50	29.80
30	20.60	19.30	14.50	15.80	59	35.10	33.80	29.00	30.30
31	21.10	19.80	15.00	16.30	60	35.60	34.30	29.50	30.80
32	21.60	20.30	15.50	16.80					
33	22.10	20.80	16.00	17.30					
34	22.60	21.30	16.50	17.80					

SPECIFICATION
 VOLTAGE RATING: 50 VAC
 CURRENT RATING: 0.4 AMP
 CONTACT RESISTANCE: 20 MOHM MAX.
 INSULATION RESISTANCE: 500 MOHM MIN.
 WITHSTANDING VOLTAGE: 200 VAC RMS.
 RELATIVE HUMIDITY: 93%+40°C
 OPERATING TEMPERATURE: -25°C ~ +85°C

MATERIALS
 HOUSING: THERMOPLASTIC (UL94V-0)
 SOLDER TAB: PHOSPHOR BRONZE TIN PLATED
 TERMINAL : PHOSPHOR BRONZE TIN PLATED
 SLIDER: THERMOPLASTIC (UL94V-0)

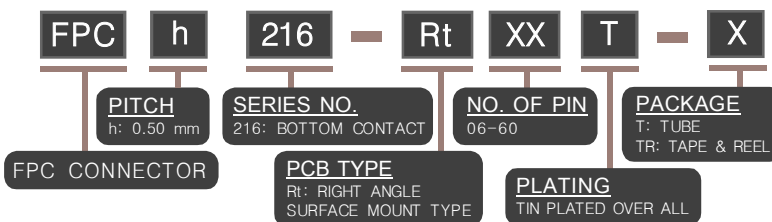

NOTE : SOME SIZES, STYLES AND OPTION ARE NON-STANDARD, NON-CANCELLABLE, NON-RETURNABLE

1.25 mm FPCu211 STRAIGHT TYPE- P

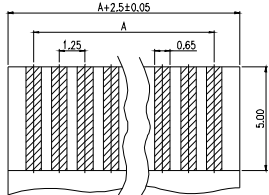
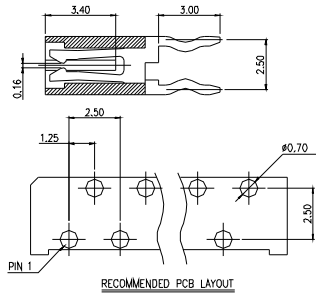
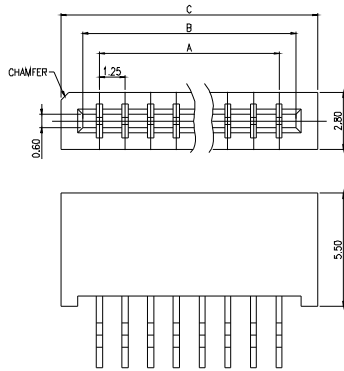

FPC/FPC T=0.30±0.05

SPECIFICATION

CURRENT RATING: AC/DC 1A
 DIELECTRIC WITHSTANDING VOLTAGE : 500VAC/1MIN
 INSULATION RESISTANCE: 1000 MEGAOHMS
 CONTACT RESISTANCE: 30 MILLIOHMS MAX
 OPERATING TEMPERATURE: -40°C ~+85°C

MATERIALS

INSULATOR: GLASS-REINFORCED THERMOPLASTIC
 CONTACT: COPPER ALLOY
 PLATING: ALL TIN, LEAD FREE

MODEL NO.	Contacts	DIMENSIONS		
		A	B	C
FPCu211-P03T	3	2.50	5.05	7.15
FPCu211-P04T	4	3.75	6.30	8.40
FPCu211-P05T	5	5.00	7.65	9.65
FPCu211-P06T	6	6.25	8.80	10.90
FPCu211-P07T	7	7.50	10.05	12.15
FPCu211-P08T	8	8.75	11.30	13.40
FPCu211-P09T	9	10.00	12.55	14.65
FPCu211-P10T	10	11.25	13.80	15.90
FPCu211-P11T	11	12.50	15.05	17.15
FPCu211-P12T	12	13.75	16.30	18.40
FPCu211-P13T	13	15.00	17.55	19.65
FPCu211-P14T	14	16.25	18.80	20.90
FPCu211-P15T	15	17.50	20.05	22.15
FPCu211-P16T	16	18.75	21.30	23.40
FPCu211-P17T	17	20.00	22.55	24.65
FPCu211-P18T	18	21.25	23.80	25.90
FPCu211-P19T	19	22.50	25.05	27.15
FPCu211-P20T	20	23.75	26.30	28.40
FPCu211-P21T	21	25.00	27.55	29.65
FPCu211-P22T	22	26.25	28.80	30.90
FPCu211-P23T	23	27.50	30.05	32.15
FPCu211-P24T	24	28.75	31.30	33.40
FPCu211-P25T	25	30.00	32.55	34.65
FPCu211-P26T	26	31.25	33.80	35.90
FPCu211-P27T	27	32.50	35.05	37.15
FPCu211-P28T	28	33.75	36.30	38.40
FPCu211-P29T	29	35.00	37.55	39.65
FPCu211-P30T	30	36.25	38.80	40.90
FPCu211-P31T	31	37.50	40.05	42.15
FPCu211-P32T	32	38.75	41.30	43.40
FPCu211-P33T	33	40.00	42.55	44.65
FPCu211-P34T	34	41.25	43.80	45.90
FPCu211-P35T	35	42.50	45.05	47.15
FPCu211-P36T	36	43.75	46.30	48.40

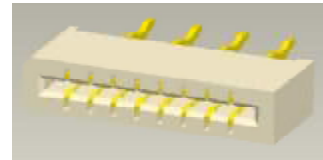
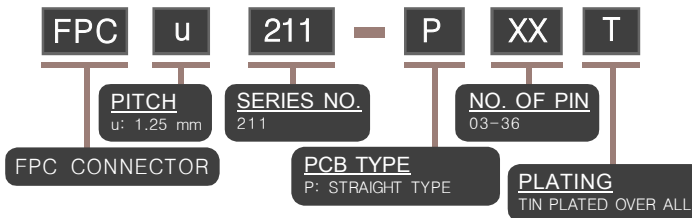

1.25 mm FPCu300 RIGHT ANGLE TYPE- Pa

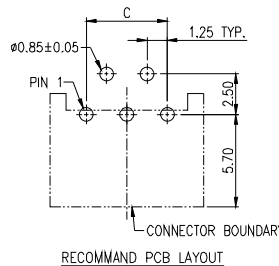
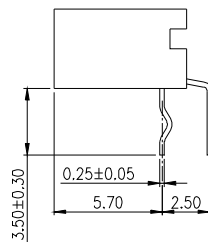
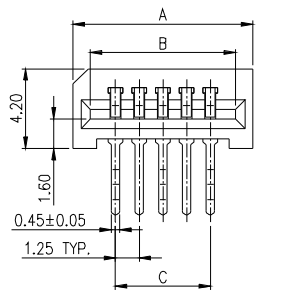
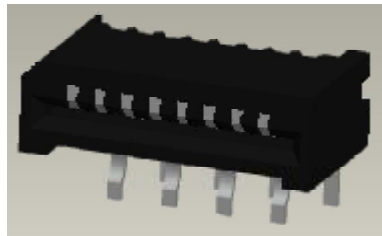
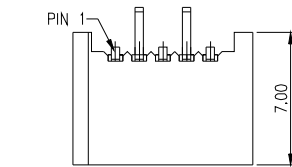

SPECIFICATION

OPERATING VOLTAGE: 200 VAC
 CURRENT RATING: 1AMP
 CONTACT RESISTANCE: 30 MILLIOHMS MAX
 INSULATION RESISTANCE: 500 MEGAOHMS
 DIELECTRIC WITHSTANDING VOLTAGE : 500VAC RMS.
 ACCOMMODATED FPC/FPC THICKNESS: 0.25±0.035MM
 OPERATING TEMPERATURE: -40°C ~+85°C

MATERIALS

INSULATOR: PA9T; UL94V-0 RATED
 INSULATOR COLOR: BLACK
 CONTACT: PHOSPHOR BRONZE

MODEL NO.	Contacts	DIMENSIONS		
		A	B	C
FPCu300-Pa04T	4	8.25	6.40	3.75
FPCu300-Pa05T	5	9.50	7.65	5.00
FPCu300-Pa06T	6	10.75	8.90	6.25
FPCu300-Pa07T	7	12.00	10.15	7.50
FPCu300-Pa08T	8	13.25	11.40	8.75
FPCu300-Pa09T	9	14.50	12.65	10.00
FPCu300-Pa10T	10	15.75	13.90	11.25
FPCu300-Pa11T	11	17.00	15.15	12.50
FPCu300-Pa12T	12	18.25	16.40	13.75
FPCu300-Pa13T	13	19.50	17.65	15.00
FPCu300-Pa14T	14	20.75	18.90	16.25
FPCu300-Pa15T	15	22.00	20.15	17.50
FPCu300-Pa16T	16	23.25	21.40	18.75
FPCu300-Pa17T	17	24.50	22.65	20.00
FPCu300-Pa18T	18	25.75	23.90	21.25
FPCu300-Pa19T	19	27.00	25.15	22.50
FPCu300-Pa20T	20	28.25	26.40	23.75
FPCu300-Pa21T	21	29.50	27.65	25.00
FPCu300-Pa22T	22	30.75	28.90	26.25
FPCu300-Pa23T	23	32.00	30.15	27.50
FPCu300-Pa24T	24	33.25	31.40	28.75
FPCu300-Pa25T	25	34.50	32.65	30.00
FPCu300-Pa26T	26	35.75	33.90	31.25
FPCu300-Pa27T	27	37.00	35.15	32.50
FPCu300-Pa28T	28	38.25	36.40	33.75
FPCu300-Pa29T	29	39.50	37.65	35.00
FPCu300-Pa30T	30	40.75	38.90	36.25
FPCu300-Pa31T	31	42.00	40.15	37.50
FPCu300-Pa32T	32	43.25	41.40	38.75
FPCu300-Pa33T	33	44.50	42.65	40.00
FPCu300-Pa34T	34	45.75	43.90	41.25

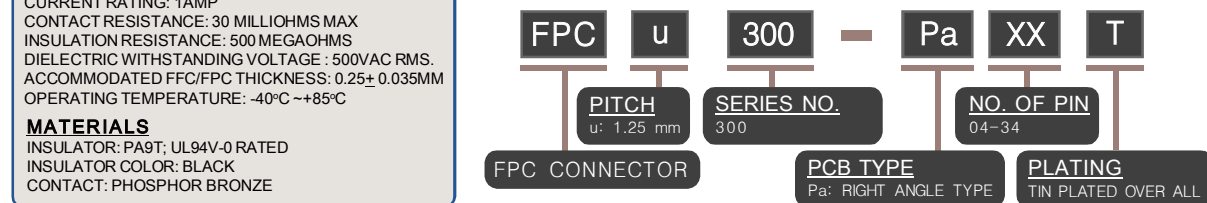

NOTE : SOME SIZES, STYLES AND OPTION ARE NON-STANDARD, NON-CANCELLABLE, NON-RETURNABLE

1.25 mm FPCu311 RIGHT ANGLE TYPE- Pa

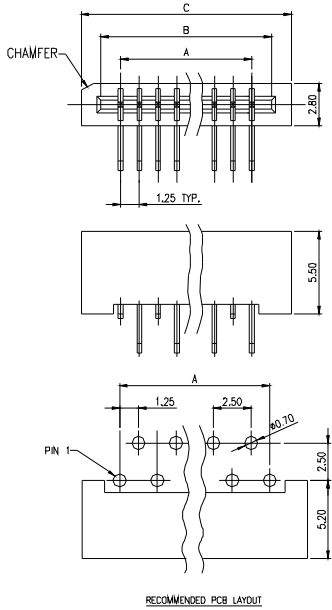

SPECIFICATION
 CURRENT RATING: 0.5 AMP
 DIELECTRIC WITHSTANDING VOLTAGE : 500VAC MIN
 INSULATION RESISTANCE: 1000 MEGAOHMS
 CONTACT RESISTANCE: 30 MILLIOHMS MAX
 TEMPERATURE RANGE: -40°C ~+85°C

MATERIALS
 INSULATOR: GLASS-REINFORCED THERMOPLASTIC
 CONTACT: COPPER ALLOY
 PLATING: ALL TIN; LEAD FREE

MODEL NO.	Contacts	DIMENSIONS		
		A	B	C
FPCu311-Pa03T	3	2.50	5.05	7.15
FPCu311-Pa04T	4	3.75	6.30	8.40
FPCu311-Pa05T	5	5.00	7.65	9.65
FPCu311-Pa06T	6	6.25	8.80	10.90
FPCu311-Pa07T	7	7.50	10.05	12.15
FPCu311-Pa08T	8	8.75	11.30	13.40
FPCu311-Pa09T	9	10.00	12.55	14.65
FPCu311-Pa10T	10	11.25	13.80	15.90
FPCu311-Pa11T	11	12.50	15.05	17.15
FPCu311-Pa12T	12	13.75	16.30	18.40
FPCu311-Pa13T	13	15.00	17.55	19.65
FPCu311-Pa14T	14	16.25	18.80	20.90
FPCu311-Pa15T	15	17.50	20.05	22.15
FPCu311-Pa16T	16	18.75	21.30	23.40
FPCu311-Pa17T	17	20.00	22.55	24.65
FPCu311-Pa18T	18	21.25	23.80	25.90
FPCu311-Pa19T	19	22.50	25.05	27.15
FPCu311-Pa20T	20	23.75	26.30	28.40
FPCu311-Pa21T	21	25.00	27.55	29.65
FPCu311-Pa22T	22	26.25	28.80	30.90
FPCu311-Pa23T	23	27.50	30.05	32.15
FPCu311-Pa24T	24	28.75	31.30	33.40
FPCu311-Pa25T	25	30.00	32.55	34.65
FPCu311-Pa26T	26	31.25	33.80	35.90
FPCu311-Pa27T	27	32.50	35.05	37.15
FPCu311-Pa28T	28	33.75	36.30	38.40
FPCu311-Pa29T	29	35.00	37.55	39.65
FPCu311-Pa30T	30	36.25	38.80	40.90
FPCu311-Pa31T	31	37.50	40.05	42.15
FPCu311-Pa32T	32	38.75	41.30	43.40
FPCu311-Pa33T	33	40.00	42.55	44.65
FPCu311-Pa34T	34	41.25	43.80	45.90
FPCu311-Pa35T	35	42.50	45.05	47.15
FPCu311-Pa36T	36	43.75	46.30	48.40

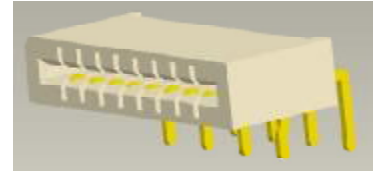
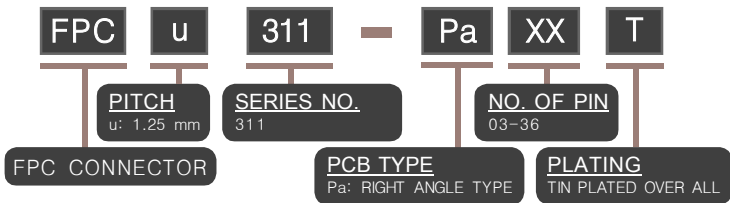

1.00 mm FCe FLAT FLEXIBLE CABLE

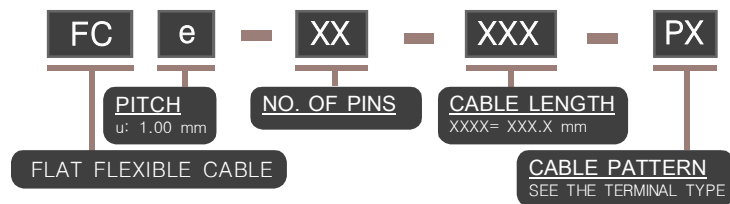
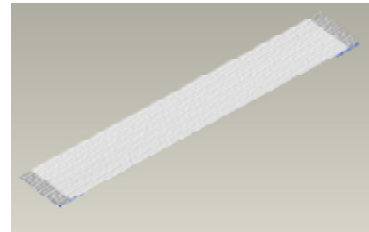
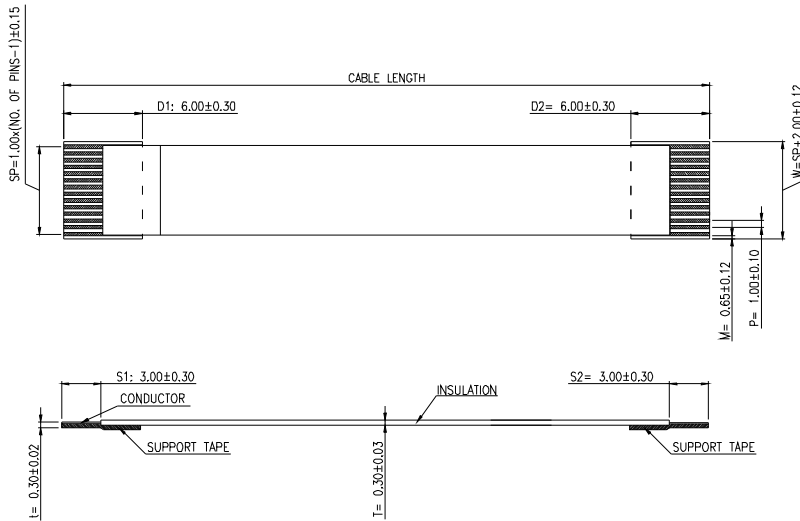

	TERMINAL TYPE
P1	
P2	
P3	
P4	
P5	
P6	
P7	
P8	
P9	
P10	
P11	
P12	
P15	

NOTE : SOME SIZES, STYLES AND OPTION ARE NON-STANDARD, NON-CANCELLABLE, NON-RETURNABLE

0.50 mm FCh FLAT FLEXIBLE CABLE

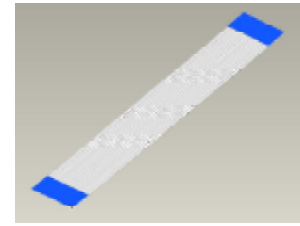
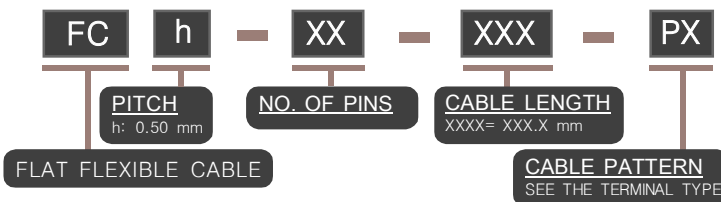
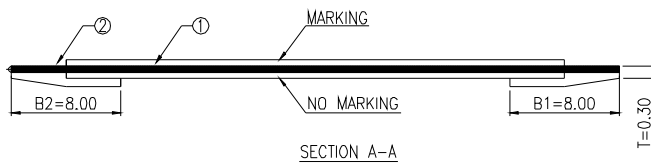
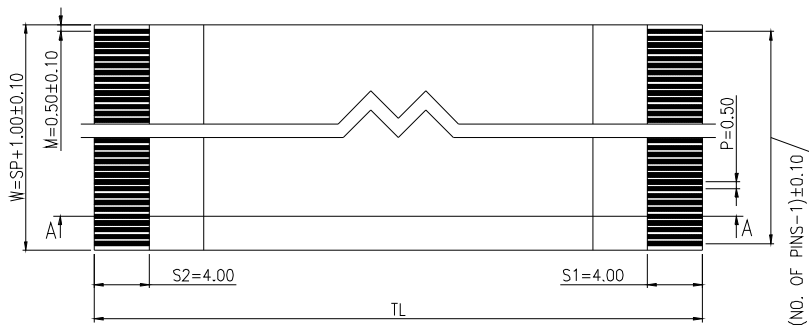

	TERMINAL TYPE
P1	
P2	
P3	
P4	
P5	
P6	
P7	
P8	
P9	
P10	
P11	
P12	
P15	

1.25 mm FCu FLAT FLEXIBLE CABLE

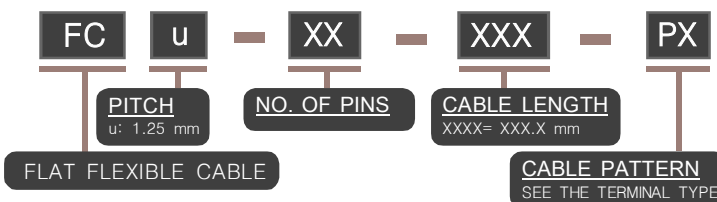
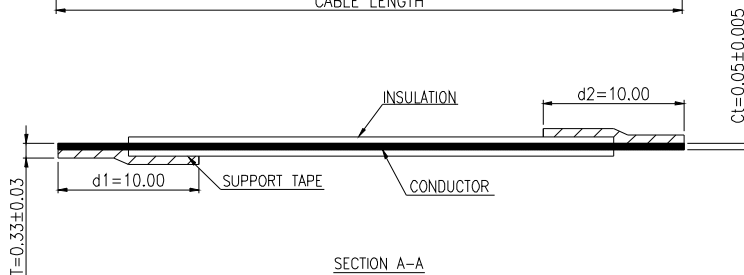
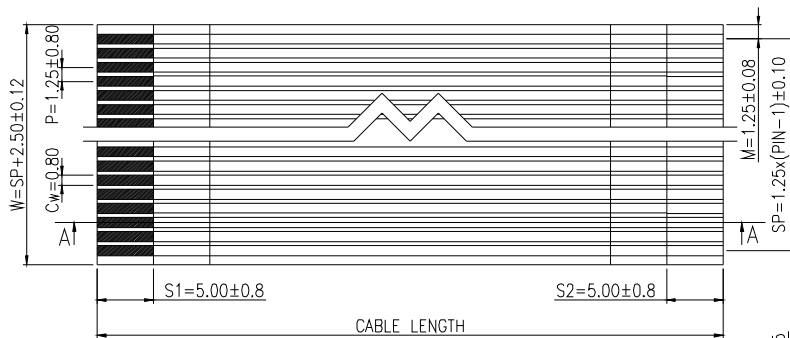

	TERMINAL TYPE
P1	
P2	
P3	
P4	
P5	
P6	
P7	
P8	
P9	
P10	
P11	
P12	
P15	

NOTE : SOME SIZES, STYLES AND OPTION ARE NON-STANDARD, NON-CANCELLABLE, NON-RETURNABLE