

MMI

**STACK D-SUB
CONNECTOR**

STACK D- SUB CONNECTOR - MOUNTING TYPE 2a RIGHT ANGLE - Pa

FF

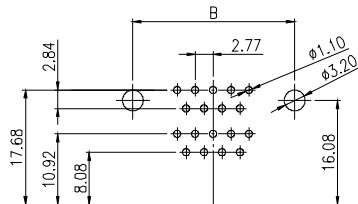
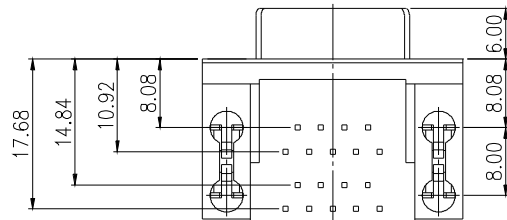
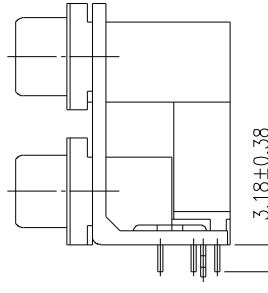
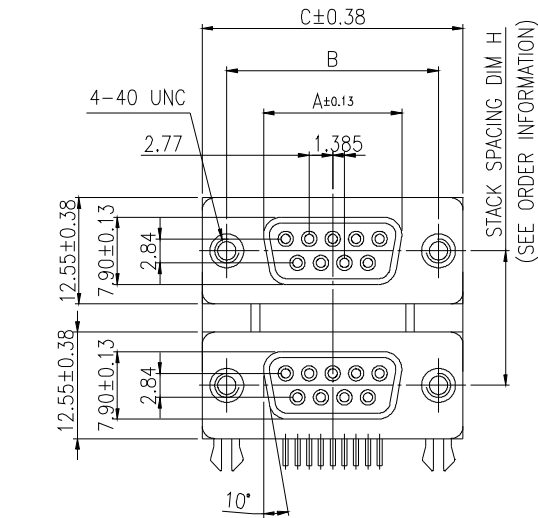

RECOMMENDED P.C. BOARD LAYOUT



MODEL NO.	NO.OF CONTACTS (SHELL SIZE)	DIMENSION		
		A	B	C
SDB0909-PoFF_GX-2a	9P	16.30	24.99	30.81
SDB1515-PoFF_GX-2a	15P	24.66	33.32	39.14
SDB2525-PoFF_GX-2a	25P	38.38	47.04	53.04
SDB3737-PoFF_GX-2a	37P	54.83	63.50	69.32

SDB | **XX** | **##** | **Pa** | **F** | **F** | **X** | **GX** | **2** | **a**

- STACK D- SUB**
- NO. OF CONTACT**
XX- UPPER: 09, 15, 25, 37
##- BOTTOM: 09, 15, 25, 37
- PCB TYPE**
Pa: RIGHT ANGLE TYPE
- GENDER**
UPPER: F - FEMALE
BOTTOM: F - FEMALE
- STACK SPACING**
1: DIM H= 15.88 mm
2: DIM H= 19.05 mm
3: DIM H= 22.86 mm
- BOARDLOCK OPTION**
2: 2 PRONG BOARDLOCK
- CONTACT PLATING OPTION**
Gf: GOLD FLASH
Gft: GOLD FLASH ON CONTACT, TIN PLATED ON SOLDER TAIL
G15t: 15u" GOLD ON CONTACT, TIN PLATED ON SOLDER TAIL
G30t: 30u" GOLD ON CONTACT, TIN PLATED ON SOLDER TAIL
- WITH #4-40UNC THREAD INSERT GROUNDING BRACKET & BOARDLOCK

ELECTRICAL CHARACTERISTIC

CONTACT CURRENT RATING: 5 AMP
CONTACT RESISTANCE: 25 M OHM MAX.
INSULATION RESISTANCE: 5000 OHM MIN.
DIELECTRIC WITHSTANDING VOLTAGE: AC 1000V / MIN
OPERATING TEMPERATURE:-55°C~ +100°C

MATERIALS

INSULATOR: PBT UL94V-0 RATED
SHELL: COLD ROLLER STEEL
CONTACTS: BRASS

NOTE : SOME SIZES, STYLES AND OPTION ARE NON-STANDARD, NON-CANCELLABLE, NON-RETURNABLE

STACK D- SUB CONNECTOR - MOUNTING TYPE 4a RIGHT ANGLE - Pa

MM

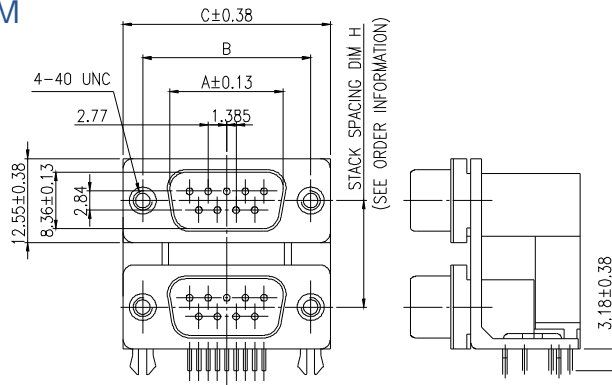

MODEL NO.	NO.OF CONTACTS (SHELL SIZE)	DIMENSION		
		A	B	C
SDB0909-PaMM1GX-4a	9P	16.92	24.99	30.81
SDB1515-PaMM1GX-4a	15P	25.25	33.32	39.14
SDB2525-PaMM1GX-4a	25P	38.96	47.04	53.04
SDB3737-PaMM1GX-4a	37P	55.42	63.50	69.32

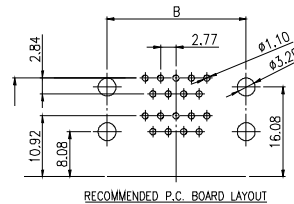
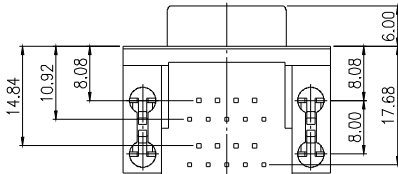

FF

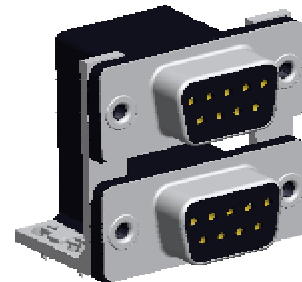
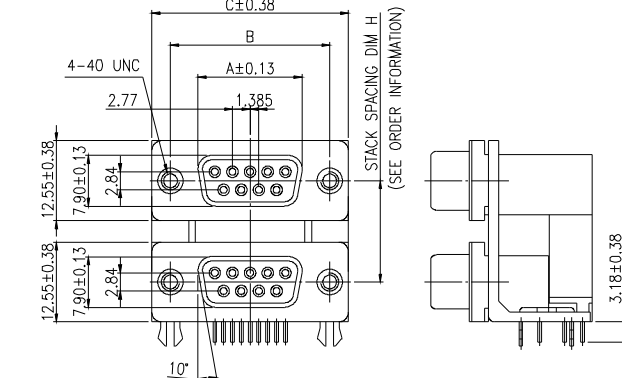

MODEL NO.	NO.OF CONTACTS (SHELL SIZE)	DIMENSION		
		A	B	C
SDB0909-PaFF_GX-4a	9P	16.30	24.99	30.81
SDB1515-PaFF_GX-4a	15P	24.66	33.32	39.14
SDB2525-PaFF_GX-4a	25P	38.38	47.04	53.04
SDB3737-PaFF_GX-4a	37P	54.83	63.50	69.32

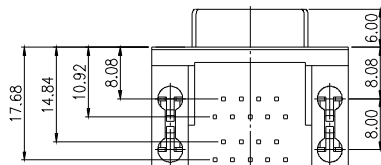

SDB XX ## - Pa X # X GX - 4 a

- STACK D- SUB**
- NO. OF CONTACT**
XX-UPPER: 09, 15, 25, 37
##-BOTTOM: 09, 15, 25, 37
- PCB TYPE**
Pa: RIGHT ANGLE TYPE
- GENDER**
X-UPPER: M - MALE, F - FEMALE
#-BOTTOM: M - MALE, F - FEMALE
- STACK SPACING**
1: DIM H= 15.88 mm
2: DIM H= 19.05 mm
3: DIM H= 22.86 mm
- BOARDLOCK OPTION**
4: 4 PRONG BOARDLOCK
- CONTACT PLATING OPTION**
Gf: GOLD FLASH
Gft: GOLD FLASH ON CONTACT, TIN PLATED ON SOLDER TAIL
G15t: 15u" GOLD ON CONTACT, TIN PLATED ON SOLDER TAIL
G30t: 30u" GOLD ON CONTACT, TIN PLATED ON SOLDER TAIL
- WITH #4-40UNC THREAD INSERT GROUNDING BRACKET & BOARDLOCK**

ELECTRICAL CHARACTERISTIC
 CONTACT CURRENT RATING: 5 AMP
 CONTACT RESISTANCE: 25 M OHM MAX.
 INSULATION RESISTANCE: 5000 OHM MIN.
 DIELECTRIC WITHSTANDING VOLTAGE: AC 1000V / MIN. RMS
 OPERATING TEMPERATURE:-55°C~ +105°C

MATERIALS
 INSULATOR: PBT UL94V-0 RATED
 SHELL: COLD ROLLER STEEL
 CONTACTS: BRASS

NOTE : SOME SIZES, STYLES AND OPTION ARE NON-STANDARD, NON-CANCELLABLE, NON-RETURNABLE

STACK D- SUB CONNECTOR - MOUNTING TYPE 4a RIGHT ANGLE - Pa

MF

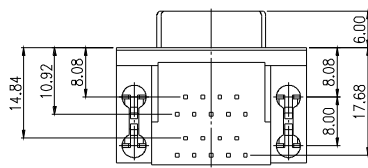
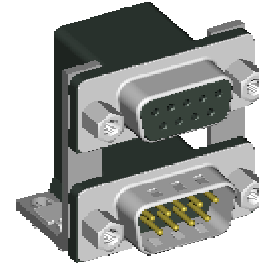
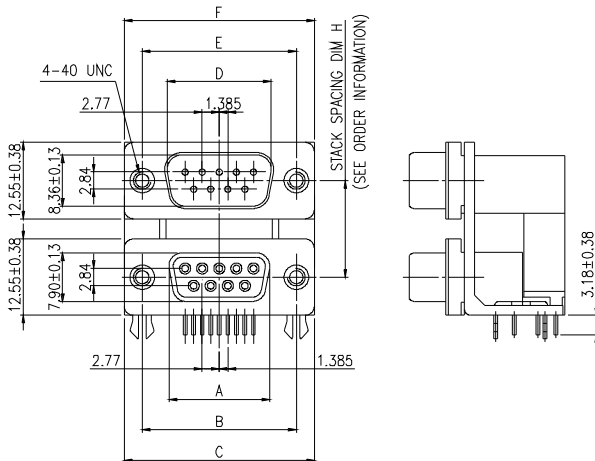

MODEL NO.	NO.OF CONTACTS (SHELL SIZE)	DIMENSION			DIMENSION		
		A	B	C	D	E	F
SDB0909-PoMF1GX-4a	9P	16.30	24.99	30.81	16.92	24.99	30.81
SDB1515-PoMF1GX-4a	15P	24.66	33.32	39.14	25.25	33.32	39.14
SDB2525-PoMF1GX-4a	25P	38.38	47.04	53.04	38.96	47.04	53.04
SDB3737-PoMF1GX-4a	37P	54.83	63.50	69.32	55.42	63.50	69.32

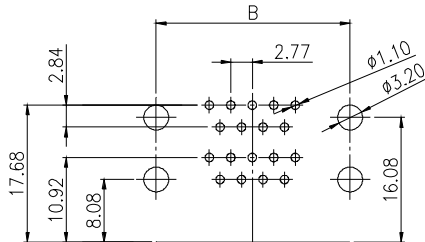

RECOMMENDED P.C. BOARD LAYOUT

FM

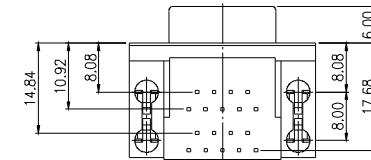
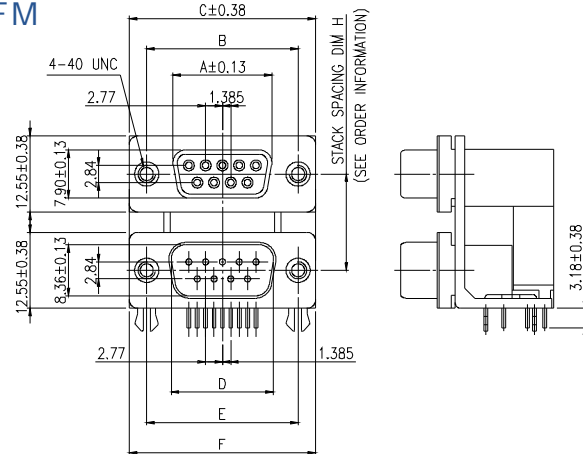

MODEL NO.	NO.OF CONTACTS (SHELL SIZE)	DIMENSION			DIMENSION		
		A	B	C	D	E	F
SDB0909-PoFM1GX-4a	9P	16.30	24.99	30.81	16.92	24.99	30.81
SDB1515-PoFM1GX-4a	15P	24.66	33.32	39.14	25.25	33.32	39.14
SDB2525-PoFM1GX-4a	25P	38.38	47.04	53.04	38.96	47.04	53.04
SDB3737-PoFM1GX-4a	37P	54.83	63.50	69.32	55.42	63.50	69.32

SDB **XX** **##** - **Pa** **X** **#** **X** **GX** - **4** **a**

STACK D- SUB

NO. OF CONTACT
XX-UPPER: 09, 15, 25, 37
##-BOTTOM: 09, 15, 25, 37

PCB TYPE
Pa: RIGHT ANGLE TYPE

GENDER
X-UPPER: M - MALE, F - FEMALE
#-BOTTOM: F - FEMALE, M - MALE

STACK SPACING
1: DIM H= 15.88 mm
2: DIM H= 19.05 mm
3: DIM H= 22.86 mm

BOARDLOCK OPTION
4: 4 PRONG BOARDLOCK

CONTACT PLATING OPTION
Gf: GOLD FLASH
Gft: GOLD FLASH ON CONTACT, TIN PLATED ON SOLDER TAIL
G15t: 15u" GOLD ON CONTACT, TIN PLATED ON SOLDER TAIL
G30t: 30u" GOLD ON CONTACT, TIN PLATED ON SOLDER TAIL

WITH #4-40UNC THREAD INSERT
GROUNDING BRACKET & BOARDLOCK

ELECTRICAL CHARACTERISTIC

CONTACT CURRENT RATING: 5 AMP
CONTACT RESISTANCE: 25 M OHM MAX.
INSULATION RESISTANCE: 5000 OHM MIN.
DIELECTRIC WITHSTANDING VOLTAGE: AC 1000V / MIN. RMS
OPERATING TEMPERATURE:-55°C~ +105°C

MATERIALS

INSULATOR: PBT UL94V-0 RATED
SHELL: COLD ROLLER STEEL
CONTACTS: BRASS

NOTE : SOME SIZES, STYLES AND OPTION ARE NON-STANDARD, NON-CANCELLABLE, NON-RETURNABLE

STACK D- SUB CONNECTOR - *MOUNTING TYPE 2a* RIGHT ANGLE - Pa

FFM

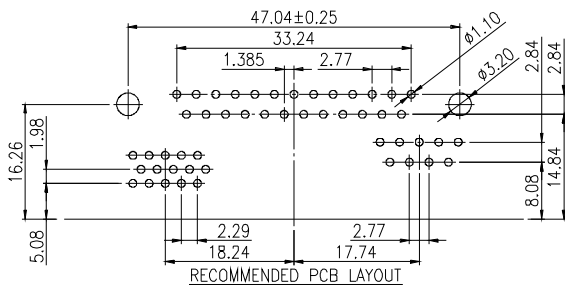
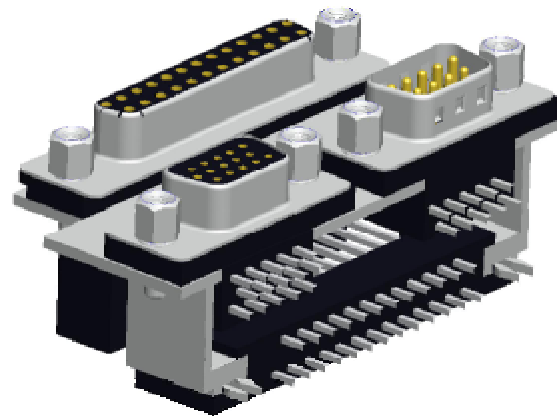
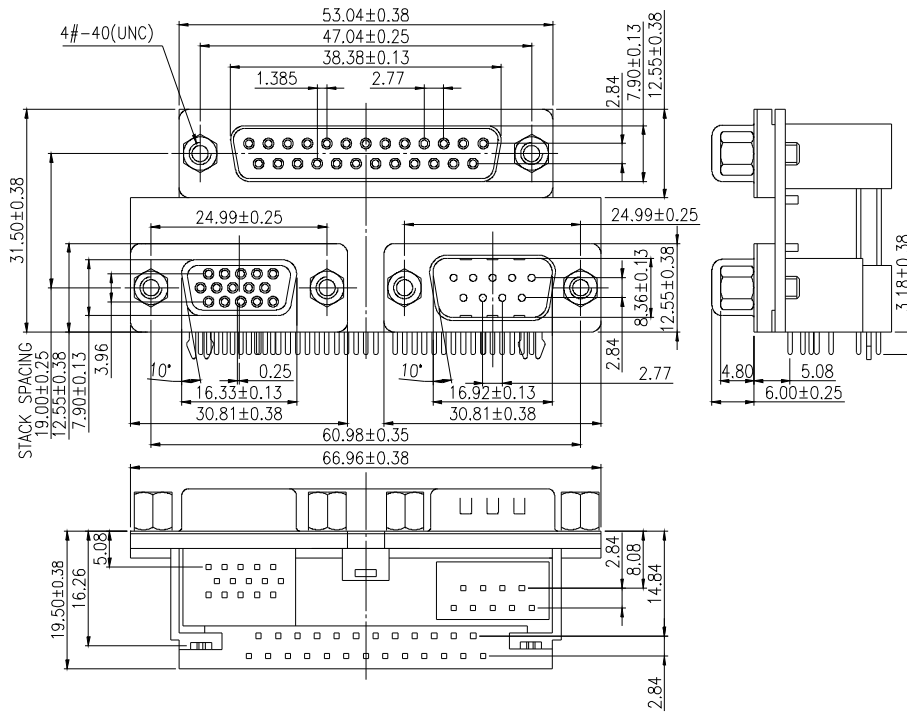

SDB XX ## Z - Pa X # Z 2 X GX - 2 a

- STACK D- SUB**
- NO. OF CONTACT**
XX- UPPER: 09, 15, 25, 37
##- BOTTOM LEFT: 00, 09, 15, 25, 37
ZZ- BOTTOM RIGHT: 00, 09, 15, 25, 37
- PCB TYPE**
Pa: RIGHT ANGLE TYPE
- GENDER**
X-UPPER: M - MALE, F - FEMALE
#-BOTTOM LEFT: M - MALE, F - FEMALE, N- WITHOUT D-SUB
#-BOTTOM RIGHT: M - MALE, F - FEMALE, N- WITHOUT D-SUB
- STACK SPACING**
2: DIM H= 19.05 mm
- CONTACT PLATING OPTION**
Gf: GOLD FLASH
G15t: 15u" GOLD ON CONTACT, TIN PLATED ON SOLDER TAIL
G30t: 30u" GOLD ON CONTACT, TIN PLATED ON SOLDER TAIL
- FOOTPRINT**
3: FOOTPRINT= 3.08mm
5: FOOTPRINT= 5.08mm
- BOARDLOCK OPTION**
WITH #4-40UNC THREAD INSERT GROUNDING BRACKET & BOARDLOCK

ELECTRICAL CHARACTERISTIC

CONTACT CURRENT RATING: 5 AMP
CONTACT RESISTANCE: 25 M OHM MAX.
INSULATION RESISTANCE: 5000 OHM MIN.
DIELECTRIC WITHSTANDING VOLTAGE: AC 1000V / MIN. RMS
OPERATING TEMPERATURE:-55°C~ +105°C

MATERIALS

INSULATOR: PBT UL94V-0 RATED
SHELL: COLD ROLLER STEEL
CONTACTS: BRASS

NOTE : SOME SIZES, STYLES AND OPTION ARE NON-STANDARD, NON-CANCELLABLE, NON-RETURNABLE

STACK D- SUB CONNECTOR - MOUNTING TYPE 3a RIGHT ANGLE - Pa

FMF

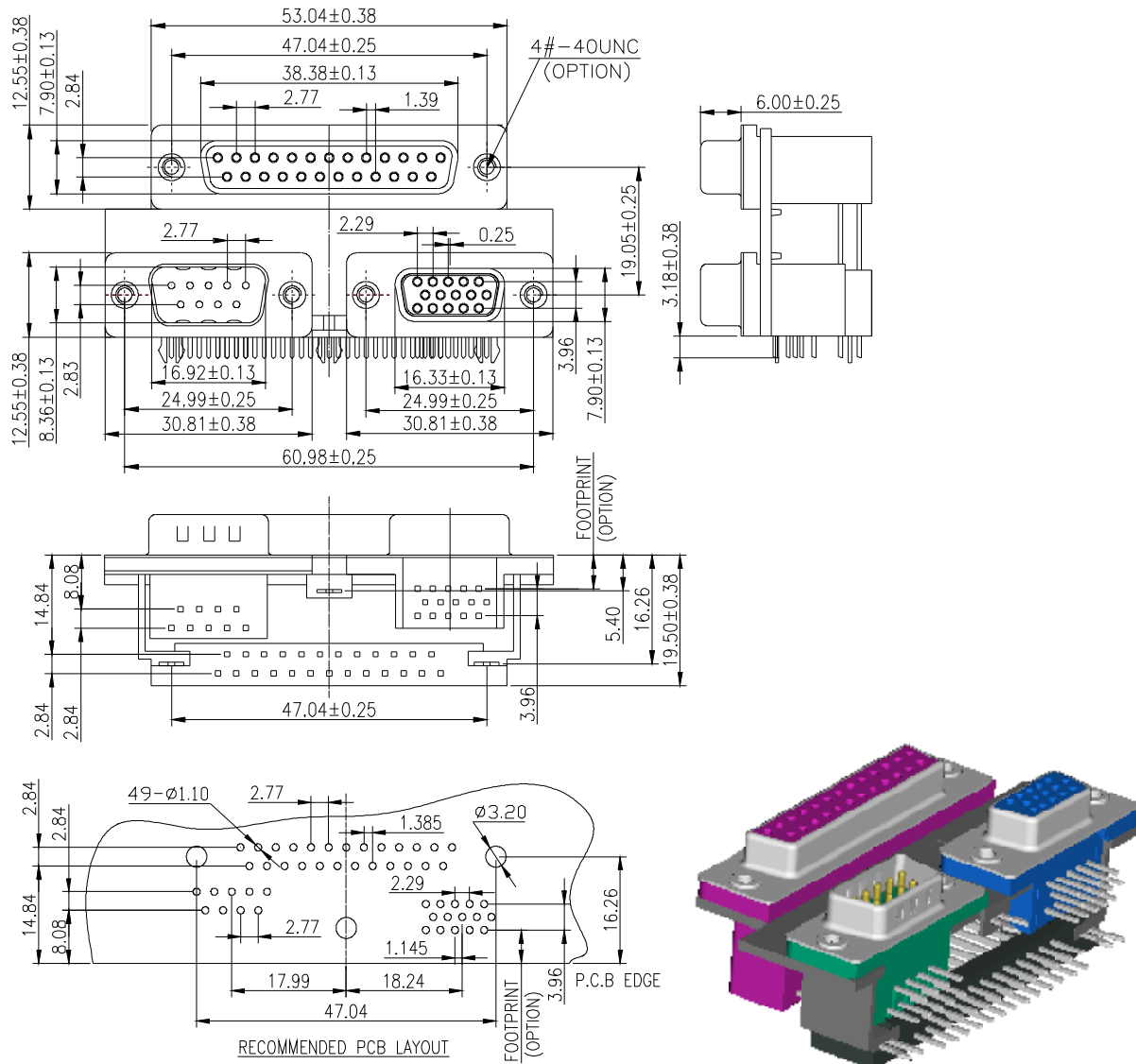

SDB XX ## Z - Pa X # Z 2 X GX - 3 a

- STACK D- SUB**
- PCB TYPE**
Pa: RIGHT ANGLE TYPE
- STACK SPACING**
2: DIM H= 19.05 mm
- FOOTPRINT**
3: FOOTPRINT= 3.08mm
5: FOOTPRINT= 5.08mm
- CONTACT PLATING OPTION**
Gf: GOLD FLASH
G1t: 15u" GOLD ON CONTACT, TIN PLATED ON SOLDER TAIL
G30t: 30u" GOLD ON CONTACT, TIN PLATED ON SOLDER TAIL
- BOARDLOCK OPTION**
3: 3 PRONG BOARDLOCK
- WITH #4-40UNC THREAD INSERT GROUNDING BRACKET & BOARDLOCK**

ELECTRICAL CHARACTERISTIC
 CONTACT CURRENT RATING: 5 AMP
 CONTACT RESISTANCE: 25 M OHM MAX.
 INSULATION RESISTANCE: 5000 OHM MIN.
 DIELECTRIC WITHSTANDING VOLTAGE: AC 1000V / MIN. RMS
 OPERATING TEMPERATURE: -55°C ~ +105°C

MATERIALS
 INSULATOR: PBT UL94V-0 RATED
 SHELL: COLD ROLLER STEEL
 CONTACTS: BRASS

NOTE : SOME SIZES, STYLES AND OPTION ARE NON-STANDARD, NON-CANCELLABLE, NON-RETURNABLE

STACK D- SUB CONNECTOR - *MOUNTING TYPE 4a* RIGHT ANGLE - Pa

FMF

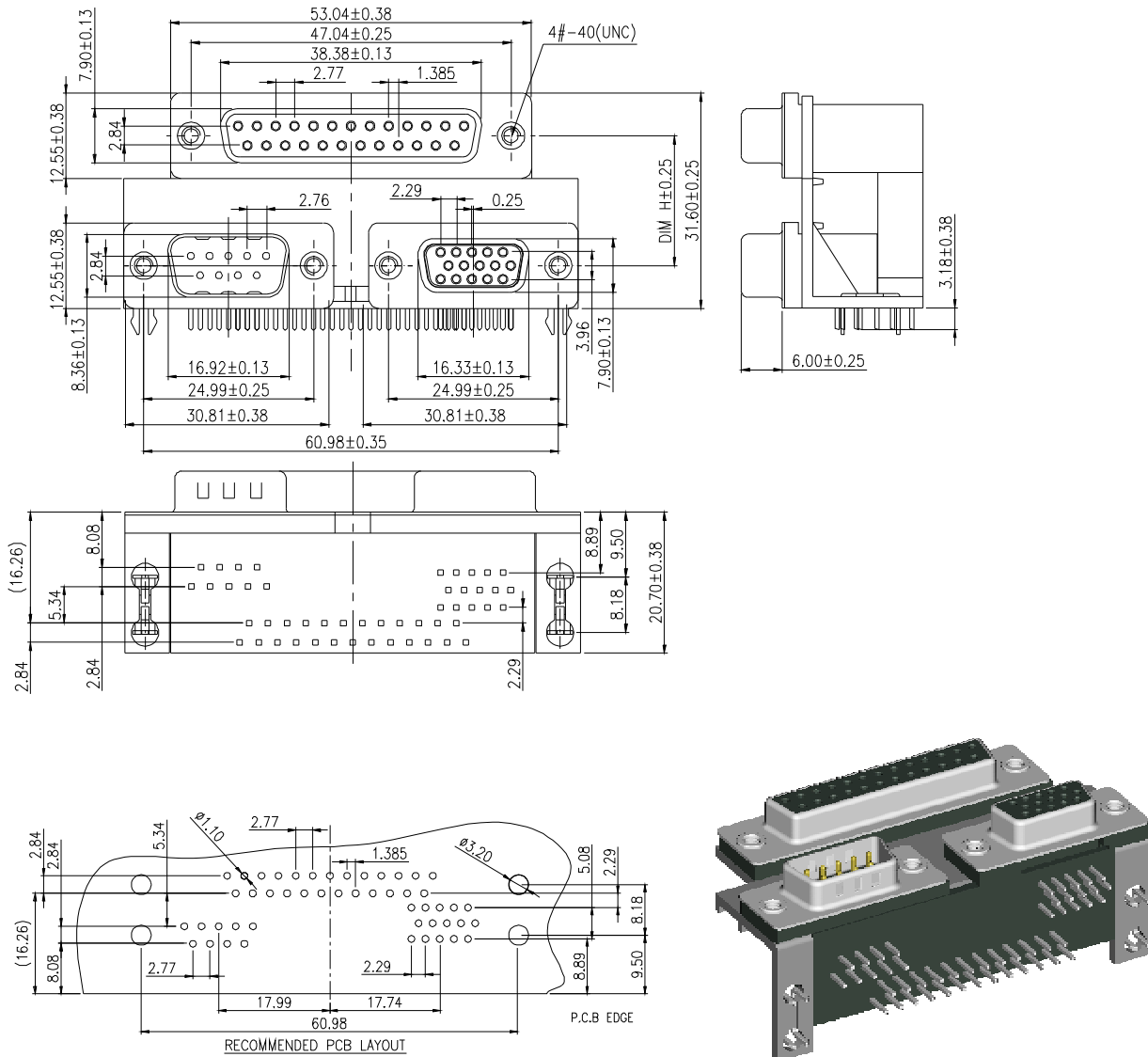

SDB	XX	##	Z	Pa	X	#	Z	X	X	GX	4	a
STACK D- SUB	PCB TYPE Pa: RIGHT ANGLE TYPE		STACK SPACING 2: DIM H= 19.05 mm		FOOTPRINT 3: FOOTPRINT= 3.08mm 5: FOOTPRINT= 5.08mm		CONTACT PLATING OPTION Gf: GOLD FLASH G15t: 15u" GOLD ON CONTACT, TIN PLATED ON SOLDER TAIL G30t: 30u" GOLD ON CONTACT, TIN PLATED ON SOLDER TAIL		BOARDLOCK OPTION 4: 4 PRONG BOARDLOCK		WITH #4-40UNC THREAD INSERT GROUNDING BRACKET & BOARDLOCK	
NO. OF CONTACT XX- UPPER: 09, 15, 25, 37 ##- BOTTOM LEFT: 00, 09, 15, 25, 37 ZZ- BOTTOM RIGHT: 09 15 25 37	GENDER X- UPPER: M - MALE, F - FEMALE #- BOTTOM LEFT: M - MALE, F - FEMALE, N- WITHOUT D-SUB #- BOTTOM RIGHT: M - MALE, F - FEMALE, N- WITHOUT D-SUB											

<p>ELECTRICAL CHARACTERISTIC CONTACT CURRENT RATING: 5 AMP CONTACT RESISTANCE: 25 M OHM MAX. INSULATION RESISTANCE: 5000 OHM MIN. DIELECTRIC WITHSTANDING VOLTAGE: AC 1000V / MIN. RMS OPERATING TEMPERATURE:-55°C~ +105°C</p>	<p>MATERIALS INSULATOR: PBT UL94V-0 RATED SHELL: COLD ROLLER STEEL CONTACTS: BRASS</p>
---	---

NOTE : SOME SIZES, STYLES AND OPTION ARE NON-STANDARD, NON-CANCELLABLE, NON-RETURNABLE

STACK HIGH DENSITY D - SUB - *MOUNTING TYPE D4a* RIGHT ANGLE - Pa

M F

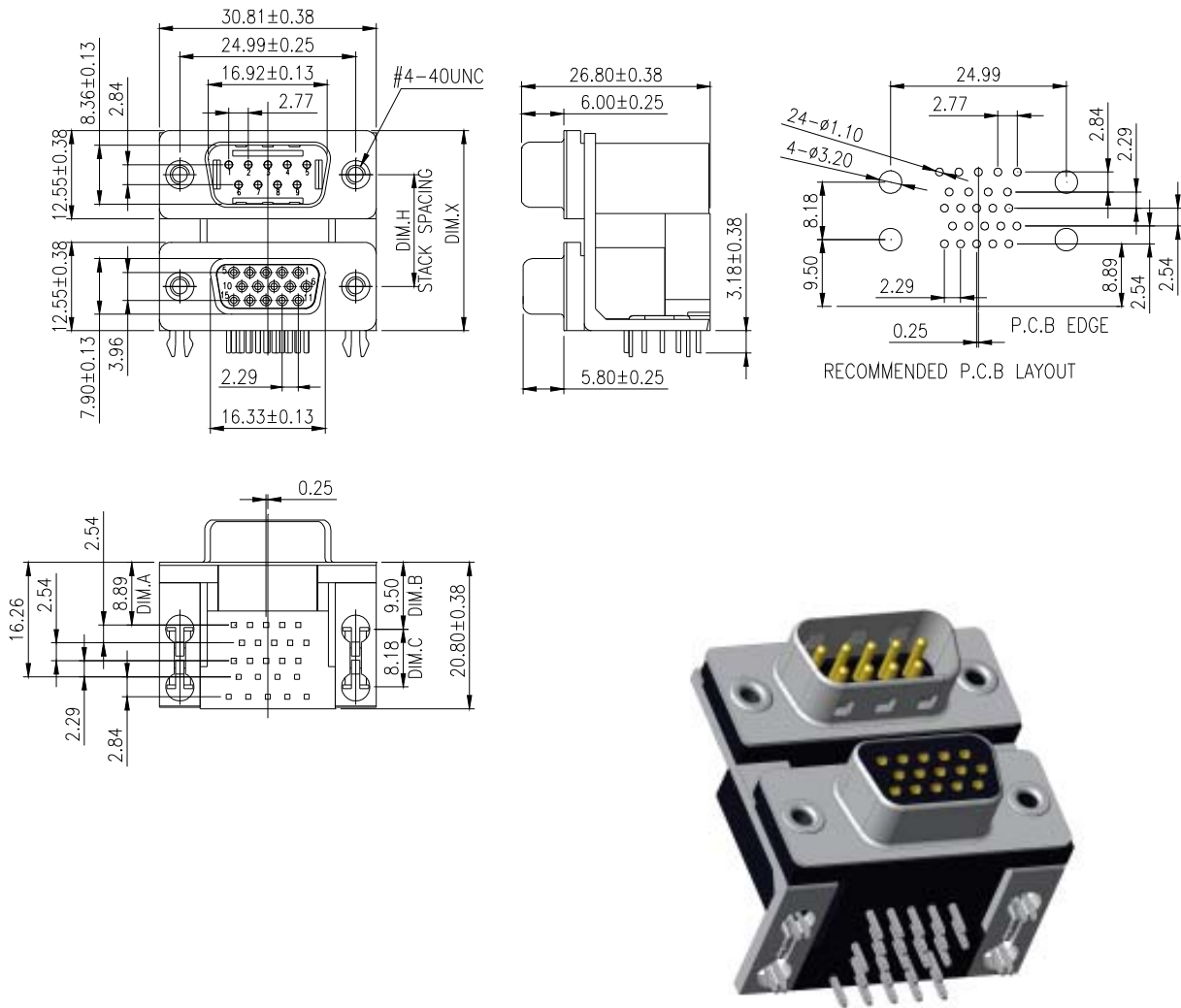

SHDB	09	15	- Pa	M	F	X	N	GX	-	D4	a	
STACK HIGH DENSITY D-SUB	NO. OF CONTACT UPPER: 09 BOTTOM: 15	PCB TYPE Pa: RIGHT ANGLE TYPE	GENDER UPPER: MALE BOTTOM: FEMALE (DIM.A=8.89)	STACK SPACING 1: DIM H. = 15.88 mm DIM X. = 28.43 mm 2: DIM H. = 19.05 mm DIM X. = 31.60 mm			FRONT SHELL FINISH N: NICKEL PLATED	BOARDLOCK OPTION D4: 4 PRONG BOARDLOCK MOUNTING DIMENSION, DIM.B=9.50 mm; DIM.C=8.18mm	CONTACT PLATING OPTION Gt: GOLD FLASH ON CONTACT, TIN PLATED ON SOLDER TAIL G15: 15µ" GOLD ON CONTACT, TIN PLATED ON SOLDER TAIL G30: 30µ" GOLD ON CONTACT, TIN PLATED ON SOLDER TAIL	WITH #4-40UNC THREAD INSERT GROUNDING BRACKET & BOARDLOCK		

<p>ELECTRICAL CHARACTERISTIC CONTACT CURRENT RATING: 3 AMP CONTACT RESISTANCE: 25 mOHM MAX. INSULATION RESISTANCE: 5000 MOHM MIN. DIELECTRIC WITHSTANDING VOLTAGE: AC 1000V / MIN RMS OPERATING TEMPERATURE: -55°C~ +85°C</p>	<p>MATERIALS INSULATOR: PBT UL94V-0 RATED SHELL: SPCC</p>
---	--

NOTE : SOME SIZES, STYLES AND OPTION ARE NON-STANDARD, NON-CANCELLABLE, NON-RETURNABLE

STACK HIGH DENSITY D - SUB - *MOUNTING TYPE 4a* RIGHT ANGLE - Pa

FF

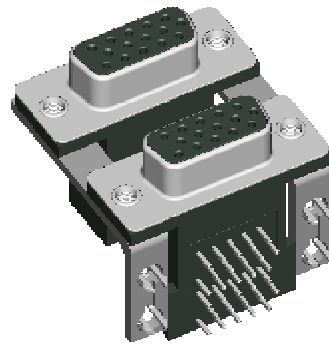
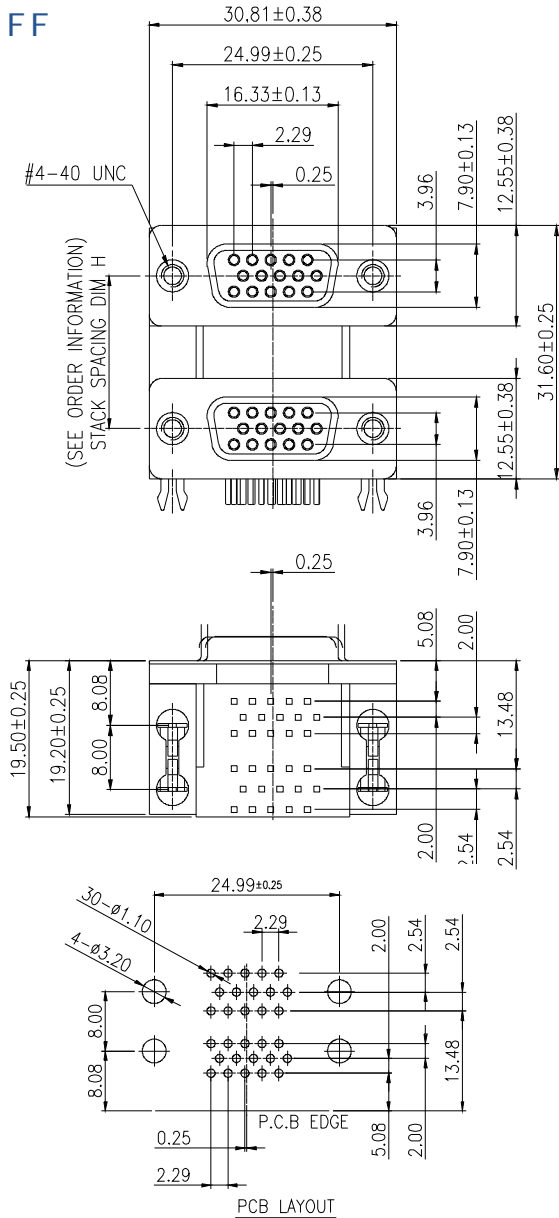

SHDB	15	15	Pa	F	F	X	GX	4	a
STACK HIGH DENSITY D- SUB	NO. OF CONTACT UPPER: 15 BOTTOM: 15	PCB TYPE Pa: RIGHT ANGLE TYPE	GENDER UPPER: FEMALE BOTTOM: FEMALE	STACK SPACING 1: DIM H= 15.88 mm 2: DIM H= 19.05 mm	CONTACT PLATING OPTION Gf: GOLD FLASH Gft: GOLD FLASH ON CONTACT, TIN PLATED ON SOLDER TAIL G15t: 15u" GOLD ON CONTACT, TIN PLATED ON SOLDER TAIL G30t: 30u" GOLD ON CONTACT, TIN PLATED ON SOLDER TAIL	BOARDLOCK OPTION 4: 4 PRONG BOARDLOCK	WITH #4-40UNC THREAD INSERT GROUNDING BRACKET & BOARDLOCK		

ELECTRICAL CHARACTERISTIC

CONTACT CURRENT RATING: 3 AMP
 CONTACT RESISTANCE: 25 M OHM MAX.
 INSULATION RESISTANCE: 5000 OHM MIN.
 DIELECTRIC WITHSTANDING VOLTAGE: AC 1000V / MIN. RMS
 OPERATING TEMPERATURE:-55°C- +105°C

MATERIALS

INSULATOR: PBT UL94V-0 RATED
 SHELL: COLD ROLLER STEEL

NOTE : SOME SIZES, STYLES AND OPTION ARE NON-STANDARD, NON-CANCELLABLE, NON-RETURNABLE

STACK HIGH DENSITY D - SUB - *MOUNTING TYPE 4D* RIGHT ANGLE - Pa

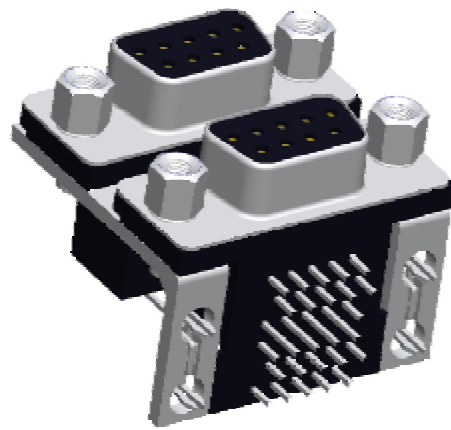
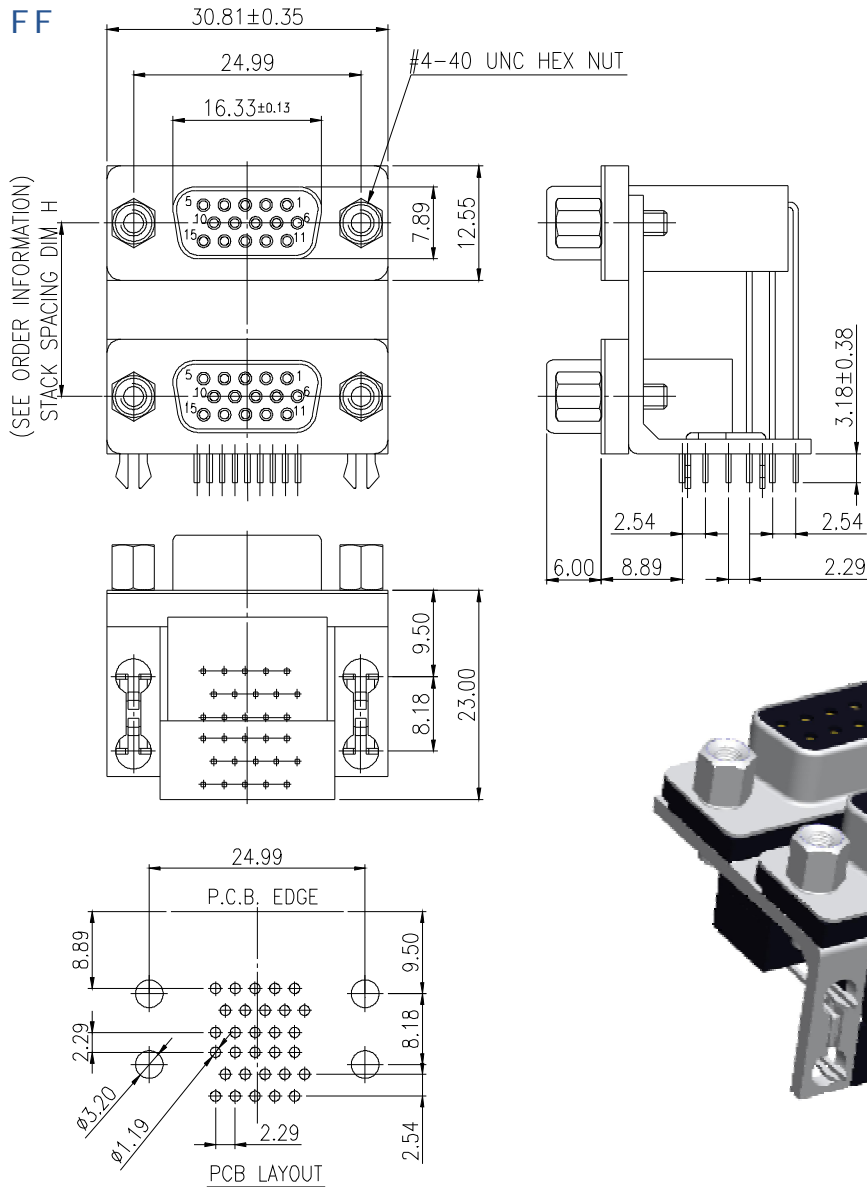

SHDB 15 15 - Pa F F X GX - 4 D

STACK HIGH DENSITY D - SUB

NO. OF CONTACT
UPPER: 15
BOTTOM: 15

PCB TYPE
Pa: RIGHT ANGLE TYPE

GENDER
UPPER: FEMALE
BOTTOM: FEMALE

STACK SPACING
1: DIM H= 15.88 mm
2: DIM H= 19.05 mm

BOARDLOCK OPTION
4: 4 PRONG BOARDLOCK

WITH FIXED #4-40UNC HEX NUT
GROUNDING BRACKET

CONTACT PLATING OPTION

Gf: GOLD FLASH
Gf: GOLD FLASH ON CONTACT, TIN PLATED ON SOLDER TAIL
G15t: 15u" GOLD ON CONTACT, TIN PLATED ON SOLDER TAIL
G30t: 30u" GOLD ON CONTACT, TIN PLATED ON SOLDER TAIL

ELECTRICAL CHARACTERISTIC

CONTACT CURRENT RATING: 3 AMP
CONTACT RESISTANCE: 25 M OHM MAX.
INSULATION RESISTANCE: 5000 OHM MIN.
DIELECTRIC WITHSTANDING VOLTAGE: AC 1000V / MIN
OPERATING TEMPERATURE:-55°C- +100°C

MATERIALS

INSULATOR: PBT UL94V-0 RATED
SHELL: COLD ROLLER STEEL

NOTE : SOME SIZES, STYLES AND OPTION ARE NON-STANDARD, NON-CANCELLABLE, NON-RETURNABLE

STACK D- SUB WITH DVI CONNECTOR

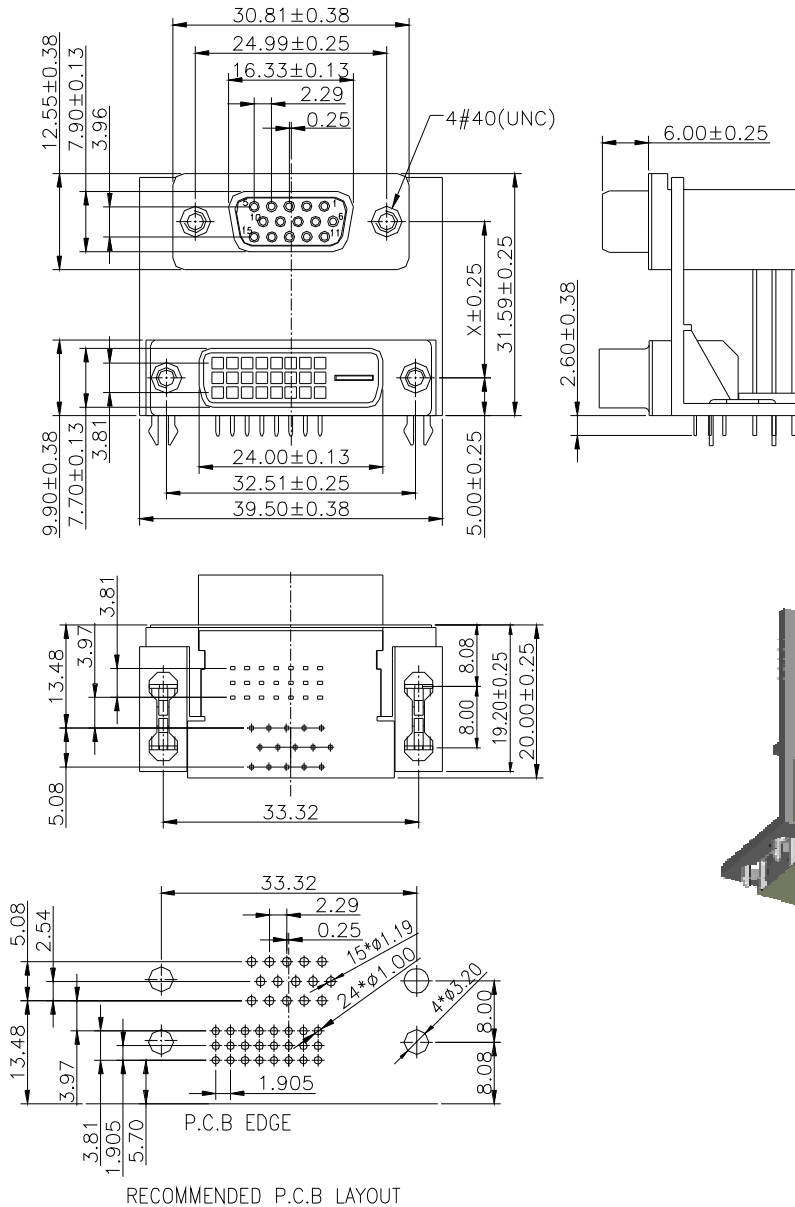

SDD	15	24	Pa	F	F	XXX	GX	4	a	
STACK D- SUB WITH DVI CONNECTOR	NO. OF CONTACT THE UPPER D-SUB: 15 THE BOTTOM DVI: 24	PCB TYPE Pa: RIGHT ANGLE TYPE	GENDER THE UPPER D-SUB: FEMAL THE BOTTOM DVI: FEMALE	STACK SPACING 2040- STACK SPACING= 20.40 MM 1715- STACK SPACING= 17.15 MM 1588- STACK SPACING= 15.88 MM			CONTACT PLATING OPTION Gf: GOLD FLASH Gf1: GOLD FLASH ON CONTACT, TIN PLATED ON SOLDER TAIL G15t: 15u" GOLD ON CONTACT, TIN PLATED ON SOLDER TAIL G30t: 30u" GOLD ON CONTACT, TIN PLATED ON SOLDER TAIL		BOARDLOCK OPTION 4: 4 PRONG BOARDLOCK	WITH #4-40UNC THREAD INSERT GROUNDING BRACKET & BOARDLOCK

ELECTRICAL CHARACTERISTIC

CONTACT CURRENT RATING: 3 AMP
CONTACT RESISTANCE: 25 M OHM MAX.
INSULATION RESISTANCE: 5000 OHM MIN.
DIELECTRIC WITHSTANDING VOLTAGE: AC 1000V / MIN
OPERATING TEMPERATURE:-55°C- +105°C

MATERIALS

INSULATOR: PBT UL94V-0 RATED
SHELL: COLD ROLLER STEEL
CONTACTS: BRASS

NOTE : SOME SIZES, STYLES AND OPTION ARE NON-STANDARD, NON-CANCELLABLE, NON-RETURNABLE

STACK D- SUB & PHONE JACK CONNECTOR RIGHT ANGLE - Pa

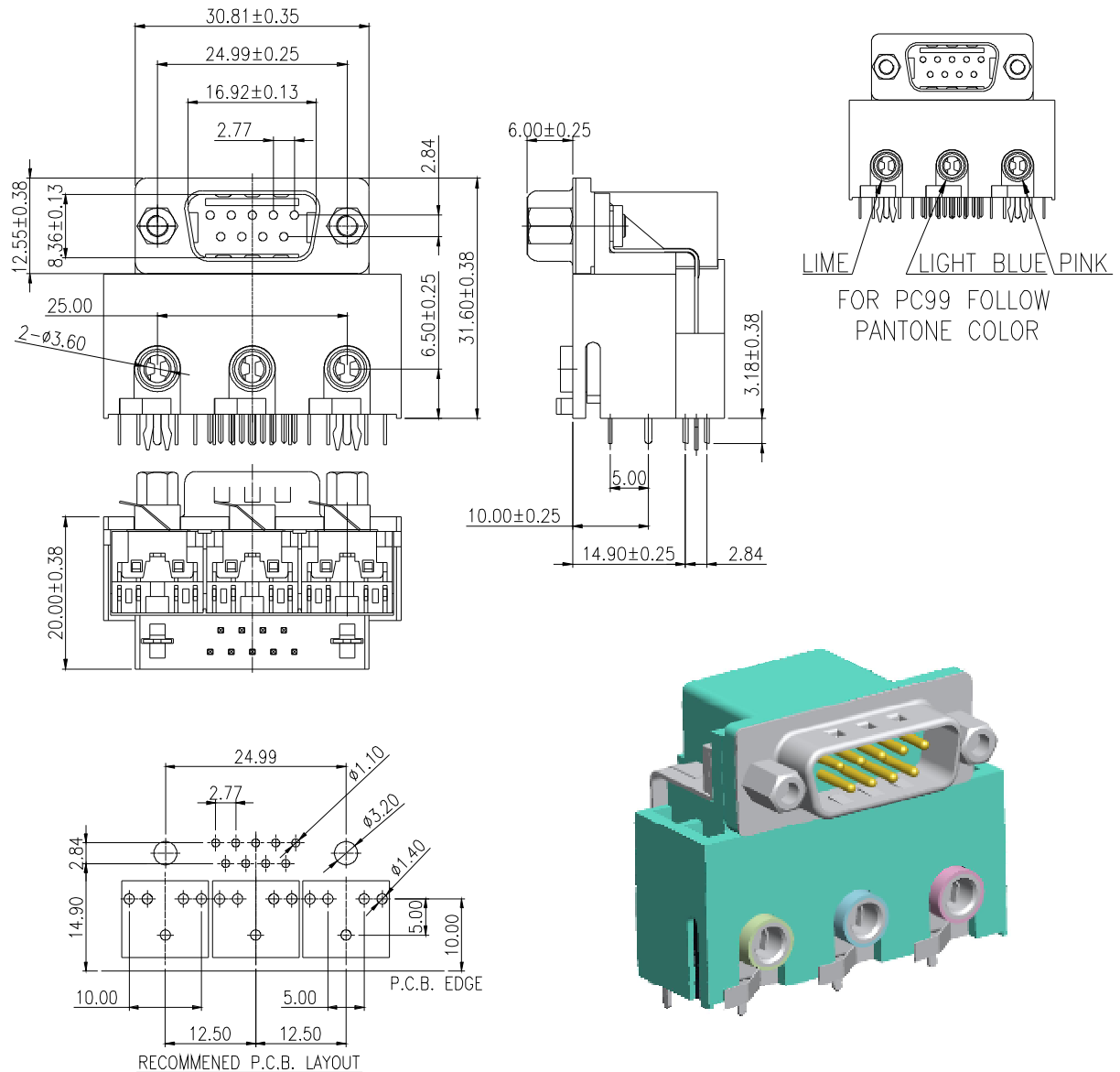

SDR - **Pa** **M** **09** **EA3** - **2** **a**

STACK D-SUB & PHONE JACK CONNECTOR

PCB TYPE
Pa: RIGHT ANGLE TYPE

GENDER
M: MALE

NO. OF CONTACT
09, 15, 25, 37, 50

EAR PHONE JACK
3: NO. OF JACKS

BOARDLOCK OPTION
2: 2 PRONG BOARD LOCK

MOUNTING TYPE
a: WITH #4-40UNC THREAD INSERT
GROUNDING BRACKET & BOARDLOCK

ELECTRICAL CHARACTERISTIC

CONTACT CURRENT RATING: 3 AMP
CONTACT RESISTANCE: 25 M OHM MAX.
INSULATION RESISTANCE: 5000 OHM MIN.
DIELECTRIC WITHSTANDING VOLTAGE: AC 1000V / MIN
OPERATING TEMPERATURE:-55°C- +105 °C

MATERIALS

INSULATOR: PBT UL94V-0 RATED
SHELL: COLD ROLLER STEEL
CONTACTS: BRASS

NOTE : SOME SIZES, STYLES AND OPTION ARE NON-STANDARD, NON-CANCELLABLE, NON-RETURNABLE