

REVISIONS				
SYM	DESCRIPTION	DATE	APPROVED	SYM
Δ				Δ
Δ				Δ

SYM	DESCRIPTION	DATE	APPROVED
Δ			
Δ			

****CUSTOMER DRAWING FOR REFERENCE ONLY, SAMPLES APPROVAL ARE REQUIRED!!**

047

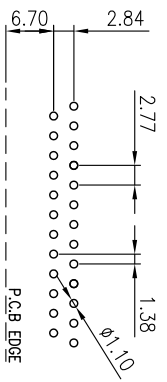
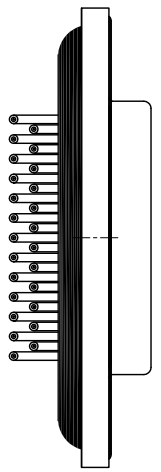
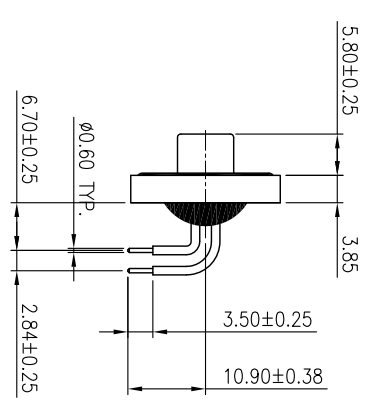
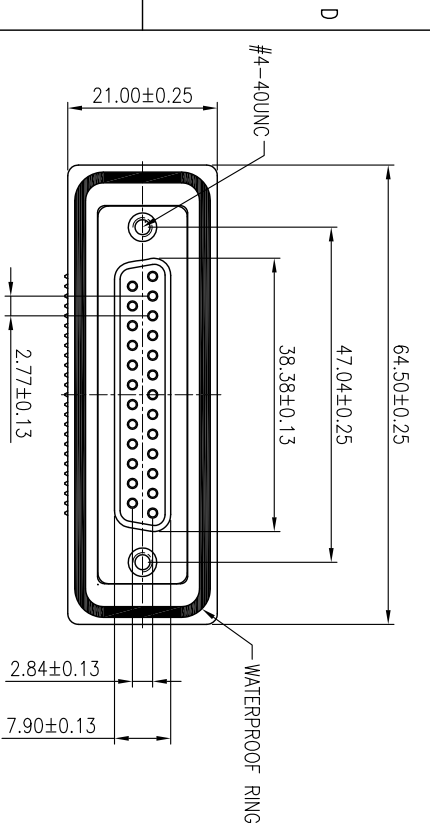

RECOMMENDED P.C.B LAYOUT

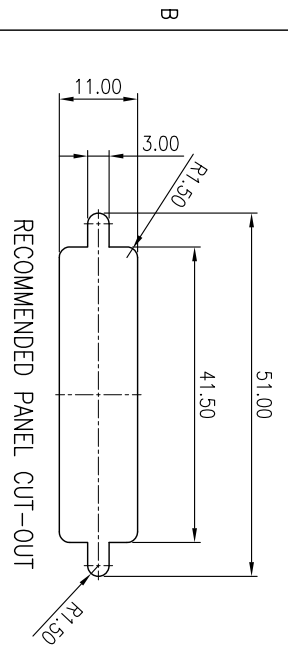

PANEL THICKNESS:
 SCREW L=4.70 FOR PANEL THICKNESS UNDER 1.20mm
 PANEL THICKNESS 1.20~2.00mm
 SCREW L=5.70 FOR PANEL THICKNESS BETWEEN 1.20~2.00mm
 PANEL THICKNESS 1.20~2.00mm

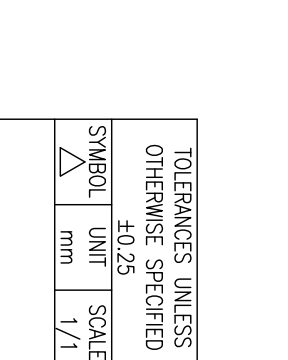
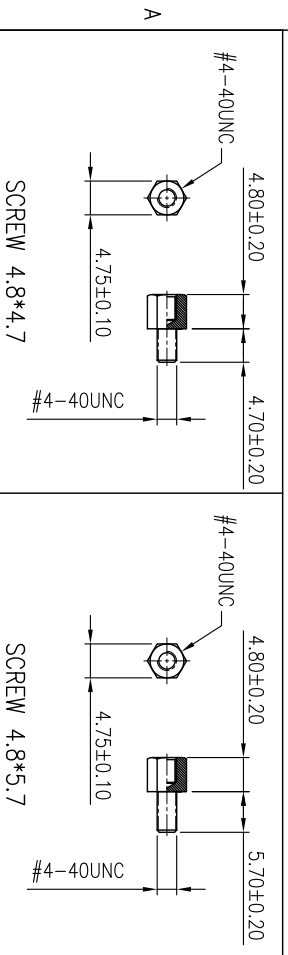
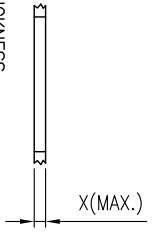

TOLERANCES UNLESS OTHERWISE SPECIFIED		SIGNATURES		DATE		MODEL	
SYMBOL	UNIT	SCALE	CHECKED	APPROVALS	DRAWN	DATE	TITLE
Δ	mm	1/1	WENDY		KEN	26/NOV/08	D-SUB WATERPROOF CONN.
						26/NOV/08	WDB940-PdF25G_--

0: #4-40 THREAD HOLE
 1: #4-40 THREAD HOLE WITH #4-40UNC SCREWLOCK
 BULK-PACKED(4.8X4.7mm & 4.8X5.7mm)

MMT CORPORATION